

INSTRUCTIONS FOR USE
WEZLANA™ (wez-LAH-nah)
(ustekinumab-auub)
injection, for subcutaneous use
single-dose prefilled syringe

This Instructions for Use contains information on how to inject WEZLANA with a prefilled syringe. The medicine in the WEZLANA prefilled syringe is for injection under-the-skin (subcutaneous injection). See the WEZLANA Medication Guide for more information about WEZLANA.

Getting to Know Your Prefilled Syringe

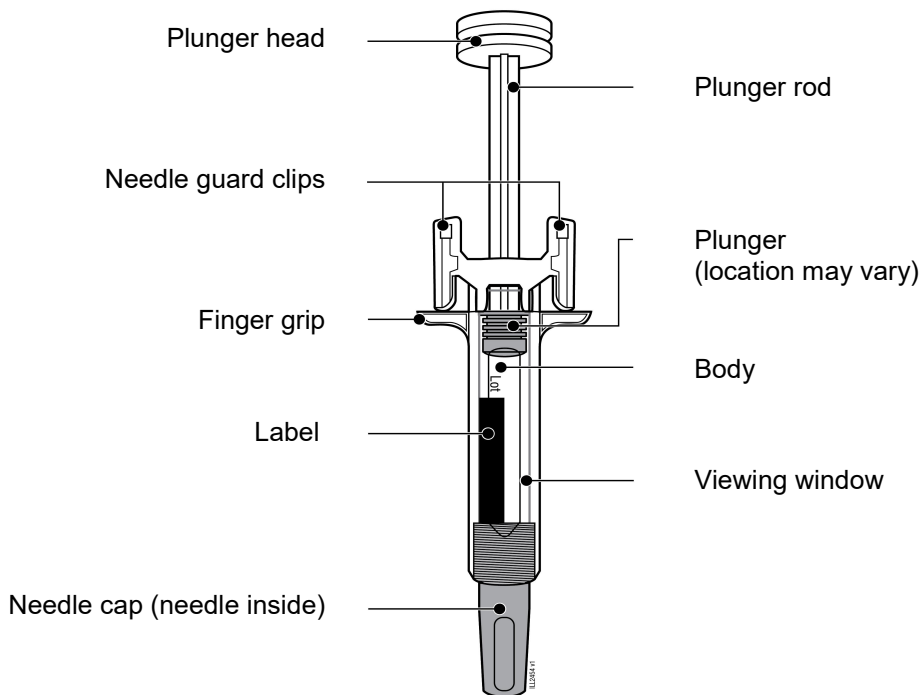

Step 1. Important Information You Need to Know Before Injecting WEZLANA

Dosing:

- WEZLANA comes in two different doses: 45 mg and 90 mg. Check your prescription to make sure you have the correct dose.
- If your dose is 45 mg, you will receive one 45 mg prefilled syringe.
- If your dose is 90 mg, you will receive either one 90 mg prefilled syringe or two 45 mg prefilled syringes.
 - If you receive two 45 mg prefilled syringes, you will need to give yourself two injections, one right after the other.
- The look of the prefilled syringe will be different for each dose. The amount of medicine in the syringe will also be different for each dose.
- The 45 mg dose will have a smaller amount of medicine and the 90 mg dose will have a larger amount of medicine. Check the figures below to see what your dose looks like in the syringe.

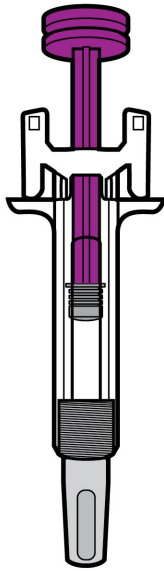

45 mg/0.5 mL

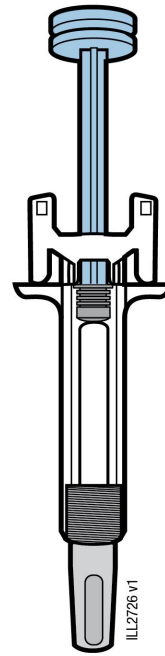

90 mg/mL

Using your WEZLANA prefilled syringe:

- It is important that you do not try to give the injection until you have fully read and understood this Instructions for Use.
- If your doctor decides that you or a caregiver can give your WEZLANA injection at home, you should receive training on the right way to prepare and inject WEZLANA. **Do not** try to inject WEZLANA yourself until you have been shown the right way to give the injections by your doctor or nurse.
- Children 12 years of age and older with psoriasis who weigh 132 pounds or more may use a prefilled syringe under supervision of a parent or caregiver.
- **Do not** use the syringe if the carton is damaged or seal is broken.
- **Do not** use the syringe after the expiration date on the label.
- **Do not** shake the syringe.
- **Do not** remove the needle cap from the syringe until you are ready to inject.
- **Do not** use the syringe if it has been frozen.
- **Do not** use the syringe if it has been dropped on a hard surface. Part of the syringe may be broken even if you cannot see the break. Use a new syringe and call 1-800-77-AMGEN (1-800-772-6436).
- The syringe is not made with natural rubber latex.

Important: Keep the syringe and sharps disposal container out of the sight and reach of children.

Frequently asked questions:

For additional information and answers to frequently asked questions, visit www.WEZLANA.com.

Where to get help:

If you want more information or help using WEZLANA:

- Contact your doctor or nurse
- Visit www.WEZLANA.com, or
- Call 1-800-77-AMGEN (1-800-772-6436).

Step 2. Storing and Preparing to Inject WEZLANA

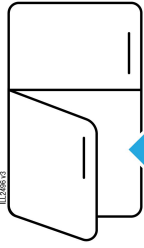

Refrigerate in carton until ready to use

2a Refrigerate the syringe carton until you are ready to use it.

- Keep the syringe in the refrigerator between 36°F to 46°F (2°C to 8°C).
- Keep the syringe in the original carton to protect it from light or physical damage until you are ready to use it.
- **Do not** freeze the syringe.
- **Do not** store the syringe in extreme heat or cold. For example, avoid storing in your vehicle's glove box or trunk.

Important: Keep the syringe out of the sight and reach of children.

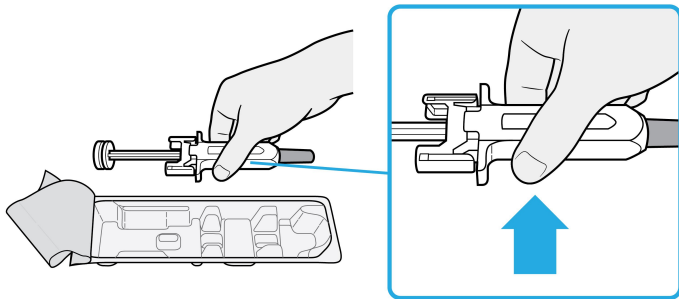

2b Grasp the syringe by the body and remove it from the carton. To prevent early activation of the needle safety guard, do not touch the **NEEDLE GUARD CLIPS** at any time during use.

- **Do not** grab the plunger rod, finger grip or the needle cap.
- **Do not** grab the needle guard clips.
- Remove the number of syringes you need for your injection.
- Put any unused syringes back into refrigerator.

WAIT



2c Wait 30 minutes for the syringe to reach room temperature.

- Let the syringe warm up naturally.

- **Do not** heat with hot water, a microwave, or direct sunlight.
- **Do not** shake the syringe at any time.
- Using the syringe at room temperature allows for a more comfortable injection.



2d You may also keep WEZLANA at room temperature for up to 30 days, if needed.

- Keep it at room temperature between 68°F to 77°F (20°C to 25°C).
- **Do not** use WEZLANA if the syringe has been stored above 86°F (30°C).
- **Do not** put WEZLANA back in refrigerator after it has been stored at room temperature.
- Record the date you removed WEZLANA from the refrigerator and use within **30** days.

Important: Place the syringe in a sharps disposal container if it has reached room temperature and has not been used within **30** days.

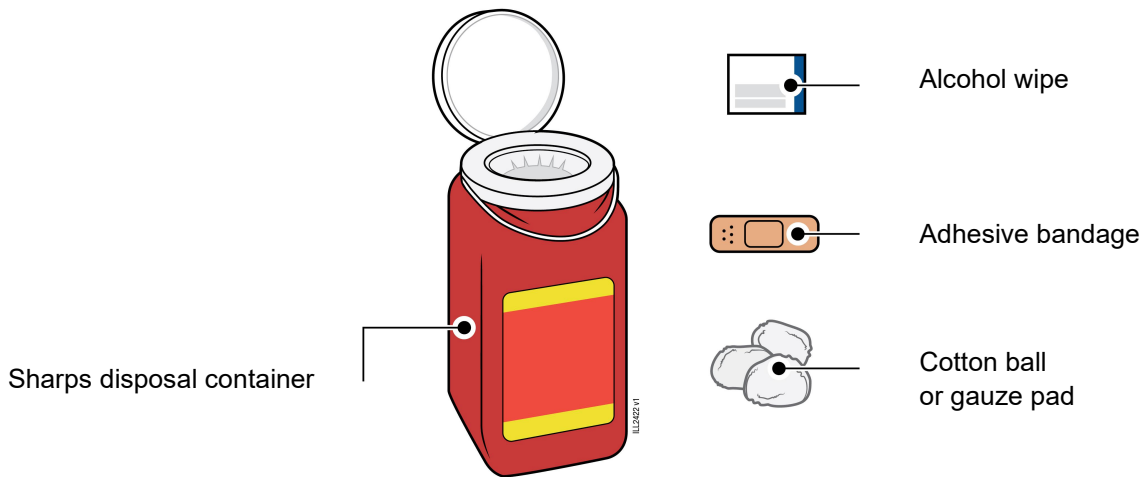

2e Gather and place the following items for your injection on a clean, flat, and well-lit surface:

- WEZLANA syringe (room temperature)
- Sharps disposal container (see Step 5. Disposing of WEZLANA and Checking the Injection Site)
- Alcohol wipe
- Adhesive bandage
- Cotton ball or gauze pad

Step 3. Getting Ready for Your Injection

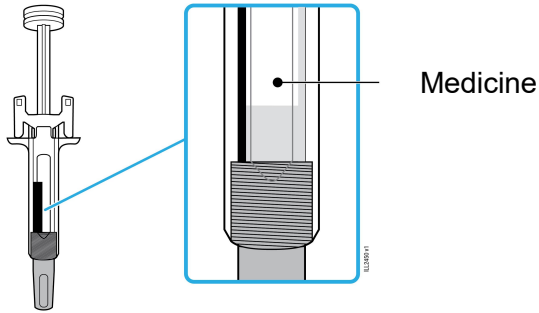

3a Inspect the medicine through the viewing window. It should be clear to white like an opal and colorless to light yellow.

- It is okay to see air bubbles.
- **Do not** use WEZLANA if the medicine is frozen, cloudy, discolored, or has large particles.

Important: If the medicine is cloudy, discolored or has flakes or if the syringe is damaged or expired, call 1-800-77-AMGEN (1-800-772-6436).

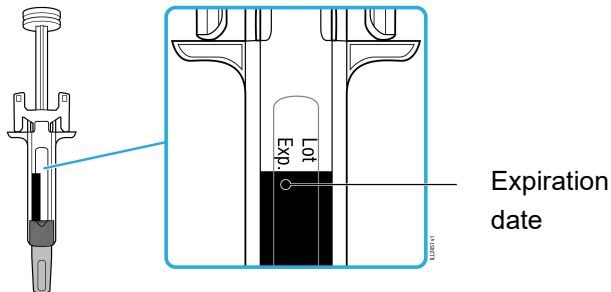

3b Check the expiration (Exp.) date and inspect the syringe for damage.

- **Do not** use if the expiration date has passed.
- **Do not** use the syringe if:
 - the needle cap is missing or loose
 - it has cracks or broken parts
 - it has been dropped on a hard surface or dropped without the needle cap in place
- Make sure you have the right medicine and dose.

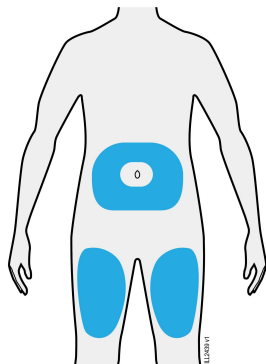

3c Choose 1 of these injection locations.

- Choose an injection site around your stomach area (abdomen) or upper legs (thighs).
- If a caregiver is giving you the injection, the outer upper area of the upper arms, or the buttocks may also be used.
- Choose a different location (site) for each injection.
- The areas in blue are the recommended injection locations.

Important: Avoid areas where the skin is tender, bruised, red, or hard.



3d Wash your hands thoroughly with soap and water.



3e Clean the injection site with alcohol wipe.

- Let your skin dry on its own.
- **Do not** touch the clean area again before injecting.

Step 4. Injecting WEZLANA

Important: Only remove the needle cap when you can inject WEZLANA right away (within 5 minutes) because the medicine can dry out.

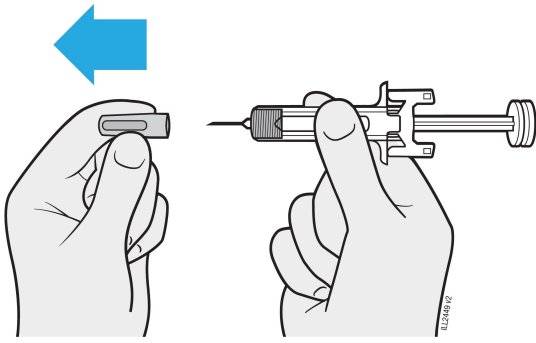

4a Pull the needle cap straight off while holding the syringe body.

- **Do not** hold the plunger or plunger head while removing the needle cap.
- **Do not** twist or bend the needle cap.
- **Never** put the needle cap back on. It may damage the needle.
- **Do not** let anything touch the needle after the cap is removed.
- **Do not** place the syringe on any surface after the cap is removed.
- **Do not** try to push air bubbles out. It is okay to see air bubbles.
- A drop of medicine at the needle tip is normal.

PINCH

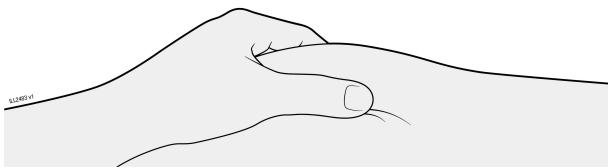

4b Pinch the skin around injection site before injection.

- Gently pinch the skin with one hand between the thumb and index finger to create a bump for the injection.
- If possible, the bump should be about 2 inches wide.

Important: Continue to pinch the skin until the injection is complete.

INSERT

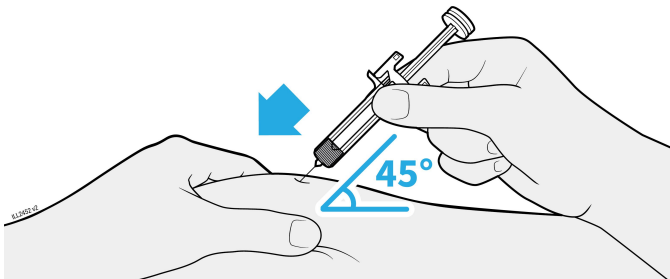

4c Insert the needle into the pinched skin.

- Insert the needle into the pinched skin at about a 45-degree angle.
- **Do not** place your finger on the plunger rod while inserting the needle, as this may result in lost medicine.

INJECT

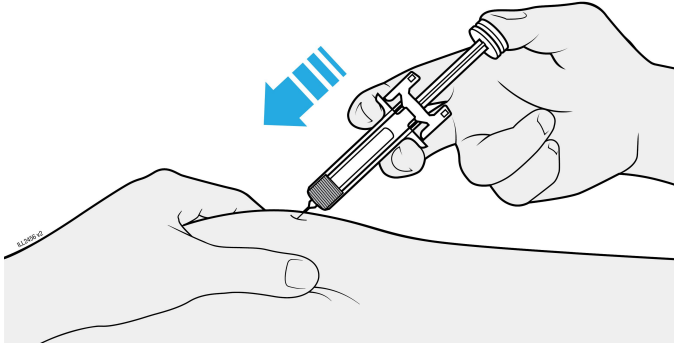

4d Slowly press the plunger head all the way down with your thumb until it is completely between the needle guard clips. Hold the finger grips with your fingers as shown in the figure.

- Do not pull back on the plunger rod at any time.
- Do not remove the syringe until all medicine has been injected.

LIFT

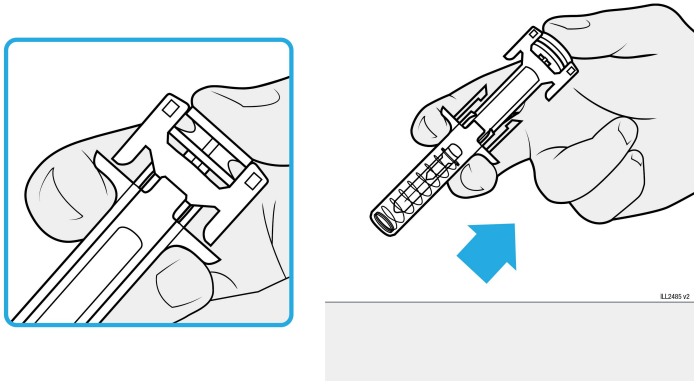

4e Keep pressure on the plunger head with your thumb and remove the needle from your skin.

- Let go of the skin after the needle is removed.
- Slowly take your thumb off the plunger head. This will let the empty syringe move up until the entire needle is automatically covered by the needle guard.

If a second injection is required:

4f Repeat steps 2a-4e if a second injection is required.

- Check your prescription for your dose.
- If your dose is 90 mg, you will receive either one 90 mg prefilled syringe or two 45 mg prefilled syringes.
 - If you receive two 45 mg prefilled syringes for a 90 mg dose, you will need to give yourself a second injection right after the first injection.
 - Repeat Steps 2a–4e for the second injection using a new WEZLANA syringe.
 - Choose a different site for the second injection.

Step 5. Disposing of WEZLANA and Checking the Injection Site

Important: Never put the needle cap back on the syringe.

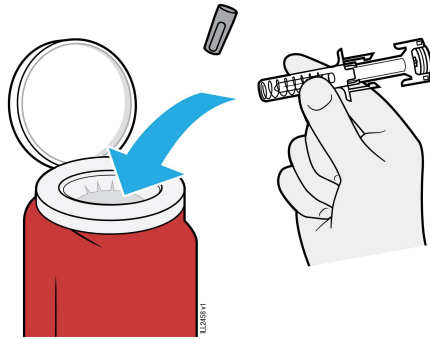

5a Place the used syringe and needle cap in an FDA-cleared sharps disposal container right away after use.

- **Do not** reuse the syringe.

Important: Do not throw away (dispose of) the syringe in your household trash.

5b Check injection site.

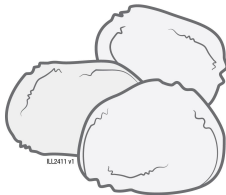
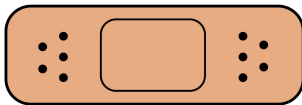

- **Do not** rub the injection site.
- If there is blood, press a cotton ball or gauze pad on your injection site.
- Apply an adhesive bandage if necessary

Additional information about your sharps disposal container

If you do not have an FDA-cleared sharps disposal container, you may use a household container that is:

- made of a heavy-duty plastic,
- can be closed with a tight-fitting, puncture-resistant lid, without sharps being able to come out,
- upright and stable during use,
- leak-resistant, and
- properly labeled to warn of hazardous waste inside the container.

Disposing of sharps containers:

When your sharps disposal container is almost full, you will need to follow your community guidelines for the right way to dispose of your sharps disposal container.

There may be state or local laws about how you should throw away used needles and syringes.

For more information about safe sharps disposal, and for specific information about sharps disposal in the state that you live in, go to the FDA's website at: <http://www.fda.gov/safesharpsdisposal>

Do not dispose of your used sharps disposal container in your household trash unless your community guidelines permit this.

Do not recycle your used sharps disposal container.

For more information or help call 1-800-77-AMGEN (1-800-772-6436).

**Manufactured by:**

Amgen Inc.
One Amgen Center Drive
Thousand Oaks, California 91320-1799
US License Number 1080

© 2023 Amgen Inc. All rights reserved.

This Instructions for Use has been approved by the U.S. Food and Drug Administration. Issued: 10/2023