

HIGHLIGHTS OF PRESCRIBING INFORMATION

These highlights do not include all the information needed to use ENBREL safely and effectively. See full prescribing information for ENBREL.

ENBREL® (etanercept) injection, for subcutaneous use
ENBREL® (etanercept) for injection, for subcutaneous use
Initial U.S. Approval: 1998

WARNING: SERIOUS INFECTIONS and MALIGNANCIES
See full prescribing information for complete boxed warning.

SERIOUS INFECTIONS

- Increased risk of serious infections leading to hospitalization or death, including tuberculosis (TB), bacterial sepsis, invasive fungal infections (such as histoplasmosis), and infections due to other opportunistic pathogens. (5.1)
- Enbrel should be discontinued if a patient develops a serious infection or sepsis during treatment. (5.1)
- Perform test for latent TB; if positive, start treatment for TB prior to starting Enbrel. (5.1)
- Monitor all patients for active TB during treatment, even if initial latent TB test is negative. (5.1)

MALIGNANCIES

- Lymphoma and other malignancies, some fatal, have been reported in children and adolescent patients treated with TNF-blockers, including Enbrel. (5.3)

INDICATIONS AND USAGE

Enbrel is a tumor necrosis factor (TNF) blocker indicated for the treatment of:

- Rheumatoid Arthritis (RA) (1.1)
- Polyarticular Juvenile Idiopathic Arthritis (JIA) in patients aged 2 years or older (1.2)
- Psoriatic Arthritis (PsA) (1.3)
- Ankylosing Spondylitis (AS) (1.4)
- Plaque Psoriasis (PsO) in patients 4 years or older (1.5)

DOSAGE AND ADMINISTRATION

Enbrel is administered by subcutaneous injection.

| Patient Population | Recommended Dose and Frequency |
|----------------------------|--|
| Adult RA and PsA (2.1) | 50 mg once weekly with or without methotrexate (MTX) |
| AS (2.1) | 50 mg once weekly |
| Adult PsO (2.1) | 50 mg twice weekly for 3 months, followed by 50 mg once weekly |
| Pediatric PsO or JIA (2.2) | 0.8 mg/kg weekly, with a maximum of 50 mg per week |

DOSAGE FORMS AND STRENGTHS

- Injection: 25 mg/0.5 mL and 50 mg/mL solution in a single-dose prefilled syringe (3)
- Injection: 50 mg/mL solution in single-dose prefilled SureClick® Autoinjector (3)
- Injection: 25 mg/0.5 mL solution in a single-dose vial (3)
- For Injection: 25 mg lyophilized powder in a multiple-dose vial for reconstitution (3)
- Injection: 50 mg/mL solution in Enbrel Mini® single-dose prefilled cartridge for use with the AutoTouch® reusable autoinjector only (3)

CONTRAINDICATIONS

Sepsis (4)

WARNINGS AND PRECAUTIONS

- Do not start Enbrel during an active infection. If an infection develops, monitor carefully and stop Enbrel if infection becomes serious. (5.1)
- Consider empiric anti-fungal therapy for patients at risk for invasive fungal infections who develop a severe systemic illness on Enbrel (those who reside or travel to regions where mycoses are endemic). (5.1)
- Demyelinating disease, exacerbation or new onset, may occur. (5.2)
- Cases of lymphoma have been observed in patients receiving TNF-blocking agents. (5.3)
- Congestive heart failure, worsening or new onset, may occur. (5.4)
- Advise patients to seek immediate medical attention if symptoms of pancytopenia or aplastic anemia develop, and consider stopping Enbrel. (5.5)
- Monitor patients previously infected with hepatitis B virus for reactivation during and several months after therapy. If reactivation occurs, consider stopping Enbrel and beginning anti-viral therapy. (5.6)
- Anaphylaxis or serious allergic reactions may occur. (5.7)
- Stop Enbrel if lupus-like syndrome or autoimmune hepatitis develops. (5.9)

ADVERSE REACTIONS

Most common adverse reactions (incidence > 5%): infections and injection site reactions. (6.1)

To report SUSPECTED ADVERSE REACTIONS, contact Amgen Inc. at 1-800-77-AMGEN (1-800-772-6436) or FDA at 1-800-FDA-1088 or www.fda.gov/medwatch.

DRUG INTERACTIONS

- Live vaccines – should not be given with Enbrel (5.8, 7.1)
- Anakinra – increased risk of serious infection (5.12, 7.2)
- Abatacept – increased risk of serious adverse events, including infections (5.12, 7.2)
- Cyclophosphamide – use with Enbrel is not recommended (7.3)

See 17 for PATIENT COUNSELING INFORMATION and Medication Guide.

Revised: 6/2022

FULL PRESCRIBING INFORMATION: CONTENTS*

WARNING: SERIOUS INFECTIONS and MALIGNANCIES

1 INDICATIONS AND USAGE

- 1.1 Rheumatoid Arthritis
- 1.2 Polyarticular Juvenile Idiopathic Arthritis
- 1.3 Psoriatic Arthritis
- 1.4 Ankylosing Spondylitis
- 1.5 Plaque Psoriasis

2 DOSAGE AND ADMINISTRATION

- 2.1 Adult Patients
- 2.2 Pediatric Patients
- 2.3 Preparation of Enbrel
- 2.4 Monitoring to Assess Safety

3 DOSAGE FORMS AND STRENGTHS

4 CONTRAINDICATIONS

5 WARNINGS AND PRECAUTIONS

- 5.1 Serious Infections
- 5.2 Neurologic Reactions
- 5.3 Malignancies
- 5.4 Patients with Heart Failure
- 5.5 Hematologic Reactions
- 5.6 Hepatitis B Reactivation
- 5.7 Allergic Reactions
- 5.8 Immunizations
- 5.9 Autoimmunity
- 5.10 Immunosuppression
- 5.11 Use in Granulomatosis with Polyangiitis Patients
- 5.12 Use with Anakinra or Abatacept
- 5.13 Use in Patients with Moderate to Severe Alcoholic Hepatitis

6 ADVERSE REACTIONS

- 6.1 Clinical Trials Experience
- 6.2 Immunogenicity
- 6.3 Postmarketing Experience

7 DRUG INTERACTIONS

- 7.1 Vaccines
- 7.2 Immune-Modulating Biologic Products
- 7.3 Cyclophosphamide
- 7.4 Sulfasalazine

8 USE IN SPECIFIC POPULATIONS

- 8.1 Pregnancy
- 8.2 Lactation
- 8.4 Pediatric Use
- 8.5 Geriatric Use
- 8.6 Use in Diabetics

10 OVERDOSAGE

11 DESCRIPTION

12 CLINICAL PHARMACOLOGY

- 12.1 Mechanism of Action
- 12.2 Pharmacodynamics
- 12.3 Pharmacokinetics

13 NONCLINICAL TOXICOLOGY

- 13.1 Carcinogenesis, Mutagenesis, Impairment of Fertility

14 CLINICAL STUDIES

- 14.1 Adult Rheumatoid Arthritis
- 14.2 Polyarticular Juvenile Idiopathic Arthritis (JIA)
- 14.3 Psoriatic Arthritis
- 14.4 Ankylosing Spondylitis
- 14.5 Adult Plaque Psoriasis
- 14.6 Pediatric Plaque Psoriasis

15 REFERENCES

16 HOW SUPPLIED/STORAGE AND HANDLING

17 PATIENT COUNSELING INFORMATION

* Sections or subsections omitted from the full prescribing information are not listed.

FULL PRESCRIBING INFORMATION

WARNING: SERIOUS INFECTIONS and MALIGNANCIES

SERIOUS INFECTIONS

Patients treated with Enbrel are at increased risk for developing serious infections that may lead to hospitalization or death [see *Warnings and Precautions (5.1) and Adverse Reactions (6)*]. Most patients who developed these infections were taking concomitant immunosuppressants such as methotrexate or corticosteroids.

Enbrel should be discontinued if a patient develops a serious infection or sepsis.

Reported infections include:

- Active tuberculosis, including reactivation of latent tuberculosis. Patients with tuberculosis have frequently presented with disseminated or extrapulmonary disease. Patients should be tested for latent tuberculosis before Enbrel use and during therapy. Treatment for latent infection should be initiated prior to Enbrel use.
- Invasive fungal infections, including histoplasmosis, coccidioidomycosis, candidiasis, aspergillosis, blastomycosis, and pneumocystosis. Patients with histoplasmosis or other invasive fungal infections may present with disseminated, rather than localized, disease. Antigen and antibody testing for histoplasmosis may be negative in some patients with active infection. Empiric anti-fungal therapy should be considered in patients at risk for invasive fungal infections who develop severe systemic illness.
- Bacterial, viral, and other infections due to opportunistic pathogens, including Legionella and Listeria.

The risks and benefits of treatment with Enbrel should be carefully considered prior to initiating therapy in patients with chronic or recurrent infection.

Patients should be closely monitored for the development of signs and symptoms of infection during and after treatment with Enbrel, including the possible development of tuberculosis in patients who tested negative for latent tuberculosis infection prior to initiating therapy.

MALIGNANCIES

Lymphoma and other malignancies, some fatal, have been reported in children and adolescent patients treated with TNF-blockers, including Enbrel.

1 INDICATIONS AND USAGE

1.1 Rheumatoid Arthritis

Enbrel is indicated for reducing signs and symptoms, inducing major clinical response, inhibiting the progression of structural damage, and improving physical function in patients with moderately to severely active rheumatoid arthritis (RA). Enbrel can be initiated in combination with methotrexate (MTX) or used alone.

1.2 Polyarticular Juvenile Idiopathic Arthritis

Enbrel is indicated for reducing signs and symptoms of moderately to severely active polyarticular juvenile idiopathic arthritis (JIA) in patients ages 2 and older.

1.3 Psoriatic Arthritis

Enbrel is indicated for reducing signs and symptoms, inhibiting the progression of structural damage of active arthritis, and improving physical function in patients with psoriatic arthritis (PsA). Enbrel can be used with or without methotrexate.

1.4 Ankylosing Spondylitis

Enbrel is indicated for reducing signs and symptoms in patients with active ankylosing spondylitis (AS).

1.5 Plaque Psoriasis

Enbrel is indicated for the treatment of patients 4 years or older with chronic moderate to severe plaque psoriasis (PsO) who are candidates for systemic therapy or phototherapy.

2 DOSAGE AND ADMINISTRATION

Administration of one 50 mg Enbrel single-dose prefilled syringe, one single-dose prefilled Enbrel SureClick autoinjector, or one Enbrel Mini single-dose prefilled cartridge (for use with the AutoTouch reusable autoinjector only), provides a dose equivalent to two 25 mg Enbrel single-dose prefilled syringes, two 25 mg single-dose vials, or two multiple-dose vials of lyophilized Enbrel, when multiple-dose vials are reconstituted and administered as recommended.

2.1 Adult Patients

Enbrel is administered by subcutaneous injection.

Table 1. Dosing and Administration for Adult Patients

| Patient Population | Recommended Dosage Strength and Frequency |
|-----------------------|---|
| Adult RA, AS, and PsA | 50 mg weekly |
| Adult PsO | <u>Starting Dose:</u> 50 mg twice weekly for 3 months <u>Maintenance Dose:</u> 50 mg once weekly |

See the Enbrel (etanercept) “Instructions for Use” insert for detailed information on injection site selection and dose administration [see *Dosage and Administration (2.3)* and *Patient Counseling Information (17)*].

Adult Rheumatoid Arthritis, Ankylosing Spondylitis, and Psoriatic Arthritis Patients

Methotrexate, glucocorticoids, salicylates, nonsteroidal anti-inflammatory drugs (NSAIDs), or analgesics may be continued during treatment with Enbrel.

Based on a study of 50 mg Enbrel twice weekly in patients with RA that suggested higher incidence of adverse reactions but similar American College of Rheumatology (ACR) response rates, doses higher than 50 mg per week are not recommended.

Adult Plaque Psoriasis Patients

In addition to the 50 mg twice weekly recommended starting dose, starting doses of 25 mg or 50 mg per week were shown to be efficacious. The proportion of responders was related to Enbrel dosage [see *Clinical Studies (14.5)*].

2.2 Pediatric Patients

Enbrel is administered by subcutaneous injection.

Table 2. Dosing and Administration for Pediatric Patients (PsO or JIA)

| Pediatric Patients Weight | Recommended Dose |
|----------------------------------|-------------------------|
| 63 kg (138 pounds) or more | 50 mg weekly |
| Less than 63 kg (138 pounds) | 0.8 mg/kg weekly |

To achieve pediatric doses other than 25 mg or 50 mg, use Enbrel solution in a single-dose vial or reconstituted lyophilized powder in a multiple-dose vial.

Doses of Enbrel higher than those described in Table 2 have not been studied in pediatric patients.

In JIA patients, glucocorticoids, NSAIDs, or analgesics may be continued during treatment with Enbrel.

2.3 Preparation of Enbrel

Enbrel is intended for use under the guidance and supervision of a physician. Patients may self-inject when deemed appropriate and if they receive medical follow-up, as necessary. Patients should not self-administer until they receive proper training in how to prepare and administer the correct dose. Administer injections subcutaneously in the thigh, abdomen or outer area of the upper arm.

The following components contain dry natural rubber (a derivative of latex), which may cause allergic reactions in individuals sensitive to latex: the needle cover of the prefilled syringe, the needle cover within the white cap of the SureClick autoinjector, and the needle cover within the purple cap of the Enbrel Mini cartridge [see *Warnings and Precautions (5.7)*].

The Enbrel (etanercept) “Instructions for Use” insert for each presentation contains more detailed instructions on injection site selection and the preparation of Enbrel.

Preparation of Enbrel Single-dose Prefilled Syringe

For a more comfortable injection, leave Enbrel prefilled syringes at room temperature for about 15 to 30 minutes before injecting. DO NOT remove the needle cover while allowing the prefilled syringe to reach room temperature.

Inspect visually for particulate matter and discoloration prior to administration. There may be small white particles of protein in the solution. This is not unusual for proteinaceous solutions. The solution should not be used if discolored or cloudy, or if foreign particulate matter is present.

When using the Enbrel single-dose prefilled syringe, check to see if the amount of liquid in the prefilled syringe falls between the two purple fill level indicator lines on the syringe. If the syringe does not have the right amount of liquid, DO NOT USE THAT SYRINGE.

Preparation of Enbrel Single-dose Prefilled SureClick Autoinjector

Leave the autoinjector at room temperature for at least 30 minutes before injecting. DO NOT remove the needle cover while allowing the prefilled syringe to reach room temperature.

Inspect visually for particulate matter and discoloration prior to administration. There may be small white particles of protein in the solution. This is not unusual for proteinaceous solutions. The solution should not be used if discolored or cloudy, or if foreign particulate matter is present.

Preparation of Enbrel Single-dose Vial

For a more comfortable injection, leave Enbrel vial(s) at room temperature for at least 30 minutes before injecting. DO NOT remove the vial cap while allowing the vial to reach room temperature.

Inspect visually for particulate matter and discoloration prior to administration. There may be small white particles of protein in the solution. This is not unusual for proteinaceous solutions. The solution should not be used if discolored or cloudy, or if foreign particulate matter is present.

When using the Enbrel single-dose vial, administer the correct dose of solution using the following recommended materials:

- A 1 mL Luer-Lock syringe.
- A withdrawal needle with Luer-Lock connection, sterile, 22-gauge, length 1 ½ inch.
- An injection needle with Luer-Lock connection, sterile, 27-gauge, length ½ inch.

Two vials may be required to administer the total prescribed dose. Use the same syringe for each vial. The vial does not contain preservatives; therefore discard unused portions.

Preparation of Enbrel Lyophilized Powder in a Multiple-dose Vial

Enbrel lyophilized powder should be reconstituted aseptically with 1 mL of the supplied Sterile Bacteriostatic Water for Injection, USP (0.9% benzyl alcohol), giving a solution of 1 mL containing 25 mg of Enbrel.

A vial adapter is supplied for use when reconstituting the lyophilized powder. However, the vial adapter should not be used if multiple doses are going to be withdrawn from the vial. If the vial will be used for multiple doses, a 25-gauge needle should be used for reconstituting and withdrawing Enbrel, and the supplied “Mixing Date:” sticker should be attached to the vial and the date of reconstitution entered. Reconstituted solution must be refrigerated at 36°F to 46°F (2°C to 8°C) and used within 14 days. Discard reconstituted solution after 14 days because product stability and sterility cannot be assured after 14 days. DO NOT store reconstituted Enbrel solution at room temperature.

For a more comfortable injection, leave the Enbrel dose tray at room temperature for about 15 to 30 minutes before injecting.

If using the vial adapter, twist the vial adapter onto the diluent syringe. Then, place the vial adapter over the Enbrel vial and insert the vial adapter into the vial stopper. Push down on the plunger to inject the diluent into the Enbrel vial. If using a 25-gauge needle to reconstitute and withdraw Enbrel, the diluent should be injected very slowly into the Enbrel vial. It is normal for some foaming to occur. Keeping the diluent syringe in place, gently swirl the contents of the Enbrel vial during dissolution. To avoid excessive foaming, do not shake or vigorously agitate.

Generally, dissolution of Enbrel takes less than 10 minutes. Do not use the solution if discolored or cloudy, or if particulate matter remains.

Withdraw the correct dose of reconstituted solution into the syringe. Some foam or bubbles may remain in the vial. Remove the syringe from the vial adapter or remove the 25-gauge needle from the syringe. Attach a 27-gauge needle to inject Enbrel.

The contents of one vial of Enbrel solution should not be mixed with, or transferred into, the contents of another vial of Enbrel. No other medications should be added to solutions containing Enbrel, and do not reconstitute Enbrel with other diluents. Do not filter reconstituted solution during preparation or administration.

Preparation of Enbrel Mini® single-dose prefilled cartridge using the AutoTouch® reusable autoinjector

Leave Enbrel Mini single-dose prefilled cartridge at room temperature for at least 30 minutes before injecting. DO NOT remove the purple cap while allowing the cartridge to reach room temperature.

Parenteral drug products should be inspected visually for particulate matter and discoloration prior to administration. There may be small white particles of protein in the solution. This is not unusual for proteinaceous solutions. The solution should not be used if discolored or cloudy, or if foreign particulate matter is present.

To use AutoTouch reusable autoinjector, open the door by pushing the door button and inserting Enbrel Mini single-dose prefilled cartridge into AutoTouch. When inserted correctly, Enbrel Mini single-dose prefilled cartridge will slide freely and completely into the door. Close the door and AutoTouch reusable autoinjector is ready for injection.

2.4 Monitoring to Assess Safety

Prior to initiating Enbrel and periodically during therapy, patients should be evaluated for active tuberculosis and tested for latent infection [see *Warnings and Precautions (5.1)*].

3 DOSAGE FORMS AND STRENGTHS

- Injection: 25 mg/0.5 mL and 50 mg/mL clear, colorless solution in a single-dose prefilled syringe
- Injection: 50 mg/mL clear, colorless solution in a single-dose prefilled SureClick autoinjector
- Injection: 25 mg/0.5 mL clear, colorless solution in a single-dose vial
- For Injection: 25 mg lyophilized powder in a multiple-dose vial for reconstitution
- Injection: 50 mg/mL clear, colorless solution in Enbrel Mini single-dose prefilled cartridge for use with the AutoTouch reusable autoinjector only

4 CONTRAINDICATIONS

Enbrel should not be administered to patients with sepsis.

5 WARNINGS AND PRECAUTIONS

5.1 Serious Infections

Patients treated with Enbrel are at increased risk for developing serious infections involving various organ systems and sites that may lead to hospitalization or death.

Opportunistic infections due to bacterial, mycobacterial, invasive fungal, viral, parasitic, or other opportunistic pathogens including aspergillosis, blastomycosis, candidiasis, coccidioidomycosis, histoplasmosis, legionellosis, listeriosis, pneumocystosis, and tuberculosis have been reported with TNF-blockers. Patients have frequently presented with disseminated rather than localized disease.

Treatment with Enbrel should not be initiated in patients with an active infection, including clinically important localized infections. Patients greater than 65 years of age, patients with co-morbid conditions, and/or patients taking concomitant immunosuppressants (such as corticosteroids or methotrexate), may be at greater risk of infection. The risks and benefits of treatment should be considered prior to initiating therapy in patients:

- With chronic or recurrent infection;
- Who have been exposed to tuberculosis;
- With a history of an opportunistic infection;
- Who have resided or traveled in areas of endemic tuberculosis or endemic mycoses, such as histoplasmosis, coccidioidomycosis, or blastomycosis; or
- With underlying conditions that may predispose them to infection, such as advanced or poorly controlled diabetes [see *Adverse Reactions (6.1)*].

Patients should be closely monitored for the development of signs and symptoms of infection during and after treatment with Enbrel.

Enbrel should be discontinued if a patient develops a serious infection or sepsis. A patient who develops a new infection during treatment with Enbrel should be closely monitored, undergo a prompt and complete diagnostic workup appropriate for an immunocompromised patient, and appropriate antimicrobial therapy should be initiated.

Tuberculosis

Cases of reactivation of tuberculosis or new tuberculosis infections have been observed in patients receiving Enbrel, including patients who have previously received treatment for latent or active tuberculosis. Data from clinical trials and preclinical studies suggest that the risk of reactivation of latent tuberculosis infection is lower with Enbrel than with TNF-blocking monoclonal antibodies. Nonetheless, postmarketing cases of tuberculosis reactivation have been reported for TNF-blockers, including Enbrel. Tuberculosis has developed in patients who tested negative for latent tuberculosis prior to initiation of therapy. Patients should be evaluated for tuberculosis risk factors and tested for latent infection prior to initiating Enbrel and periodically during therapy. Tests for latent tuberculosis infection may be falsely negative while on therapy with Enbrel.

Treatment of latent tuberculosis infection prior to therapy with TNF-blocking agents has been shown to reduce the risk of tuberculosis reactivation during therapy. Induration of 5 mm or greater with tuberculin skin testing should be considered a positive test result when assessing if treatment for latent tuberculosis is needed prior to initiating Enbrel, even for patients previously vaccinated with Bacillus Calmette-Guerin (BCG).

Anti-tuberculosis therapy should also be considered prior to initiation of Enbrel in patients with a past history of latent or active tuberculosis in whom an adequate course of treatment cannot be confirmed, and for patients with a negative test for latent tuberculosis but having risk factors for tuberculosis infection. Consultation with a physician with expertise in the treatment of tuberculosis is recommended to aid in the decision whether initiating anti-tuberculosis therapy is appropriate for an individual patient.

Tuberculosis should be strongly considered in patients who develop a new infection during Enbrel treatment, especially in patients who have previously or recently traveled to countries with a high prevalence of tuberculosis, or who have had close contact with a person with active tuberculosis.

Invasive Fungal Infections

Cases of serious and sometimes fatal fungal infections, including histoplasmosis, have been reported with TNF-blockers, including Enbrel. For patients who reside or travel in regions where mycoses are endemic, invasive fungal infection should be suspected if they develop a serious systemic illness. Appropriate empiric anti-fungal therapy should be considered while a diagnostic workup is being performed. Antigen and antibody testing for histoplasmosis may be negative in some patients with active infection. When feasible, the decision to administer empiric anti-fungal therapy in these patients should be made in consultation with a physician with expertise in the diagnosis and treatment of invasive fungal infections and should take into account both the risk for severe fungal infection and the risks of anti-fungal therapy. In 38 Enbrel clinical trials and 4 cohort studies in all approved indications representing 27,169 patient-years of exposure (17,696 patients) from the United States and Canada, no histoplasmosis infections were reported among patients treated with Enbrel.

5.2 Neurologic Reactions

Treatment with TNF-blocking agents, including Enbrel, has been associated with rare (< 0.1%) cases of new onset or exacerbation of central nervous system demyelinating disorders, some presenting with mental status changes and some associated with permanent disability, and with peripheral nervous system demyelinating disorders. Cases of transverse myelitis, optic neuritis, multiple sclerosis, Guillain-Barre syndromes, other peripheral demyelinating neuropathies, and new onset or exacerbation of seizure disorders have been reported in postmarketing experience with Enbrel therapy. Prescribers should exercise caution in considering the use of Enbrel in patients with preexisting or recent-onset central or peripheral nervous system demyelinating disorders [*see Postmarketing Experience (6.3)*].

5.3 Malignancies

Lymphomas

In the controlled portions of clinical trials of TNF-blocking agents, more cases of lymphoma have been observed among patients receiving a TNF-blocker compared to control patients. During the controlled portions of Enbrel trials in adult patients with RA, AS, and PsA, 2 lymphomas were observed among 3306 Enbrel-treated patients versus 0 among 1521 control patients (duration of controlled treatment ranged from 3 to 36 months).

Among 6543 adult rheumatology (RA, PsA, AS) patients treated with Enbrel in controlled and uncontrolled portions of clinical trials, representing approximately 12,845 patient-years of therapy, the observed rate of lymphoma was 0.10 cases per 100 patient-years. This was 3-fold higher than the rate of lymphoma expected in the general U.S. population based on the Surveillance, Epidemiology, and End Results (SEER) Database. An increased rate of lymphoma up to several-fold has been reported in the RA patient population, and may be further increased in patients with more severe disease activity.

Among 4410 adult PsO patients treated with Enbrel in clinical trials up to 36 months, representing approximately 4278 patient-years of therapy, the observed rate of lymphoma was 0.05 cases per 100 patient-years, which is comparable to the rate in the general population. No cases were observed in Enbrel- or placebo-treated patients during the controlled portions of these trials.

Leukemia

Cases of acute and chronic leukemia have been reported in association with postmarketing TNF-blocker use in rheumatoid arthritis and other indications. Even in the absence of TNF-blocker therapy, patients with rheumatoid arthritis may be at higher risk (approximately 2-fold) than the general population for the development of leukemia.

During the controlled portions of Enbrel trials, 2 cases of leukemia were observed among 5445 (0.06 cases per 100 patient-years) Enbrel-treated patients versus 0 among 2890 (0%) control patients (duration of controlled treatment ranged from 3 to 48 months).

Among 15,401 patients treated with Enbrel in controlled and open portions of clinical trials representing approximately 23,325 patient-years of therapy, the observed rate of leukemia was 0.03 cases per 100 patient-years.

Other Malignancies

Information is available from 10,953 adult patients with 17,123 patient-years and 696 pediatric patients with 1282 patient-years of experience across 45 Enbrel clinical studies.

For malignancies other than lymphoma and non-melanoma skin cancer, there was no difference in exposure-adjusted rates between the Enbrel and control arms in the controlled portions of clinical studies for all indications. Analysis of the malignancy rate in combined controlled and uncontrolled portions of studies has demonstrated that types and rates are similar to what is expected in the general U.S. population based on the SEER database and suggests no increase in rates over time. Whether treatment with Enbrel might influence the development and course of malignancies in adults is unknown.

Melanoma and Non-Melanoma Skin Cancer (NMSC)

Melanoma and non-melanoma skin cancer has been reported in patients treated with TNF antagonists including etanercept.

Among 15,401 patients treated with Enbrel in controlled and open portions of clinical trials representing approximately 23,325 patient-years of therapy, the observed rate of melanoma was 0.043 cases per 100 patient-years.

Among 3306 adult rheumatology (RA, PsA, AS) patients treated with Enbrel in controlled clinical trials representing approximately 2669 patient-years of therapy, the observed rate of NMSC was 0.41 cases per 100 patient-years versus 0.37 cases per 100 patient-years among 1521 control-treated patients representing 1077 patient-years. Among 1245 adult PsO patients treated with Enbrel in controlled clinical trials, representing approximately 283

patient-years of therapy, the observed rate of NMSC was 3.54 cases per 100 patient-years versus 1.28 cases per 100 patient-years among 720 control-treated patients representing 156 patient-years.

Postmarketing cases of Merkel cell carcinoma have been reported very infrequently in patients treated with Enbrel.

Periodic skin examinations should be considered for all patients at increased risk for skin cancer.

Pediatric Patients

Malignancies, some fatal, have been reported among children, adolescents, and young adults who received treatment with TNF-blocking agents (initiation of therapy at ≤ 18 years of age), including Enbrel. Approximately half the cases were lymphomas, including Hodgkin's and non-Hodgkin's lymphoma. The other cases represented a variety of different malignancies and included rare malignancies usually associated with immunosuppression and malignancies that are not usually observed in children and adolescents. The malignancies occurred after a median of 30 months of therapy (range 1 to 84 months). Most of the patients were receiving concomitant immunosuppressants. These cases were reported postmarketing and are derived from a variety of sources, including registries and spontaneous postmarketing reports.

In clinical trials of 1140 pediatric patients representing 1927.2 patient-years of therapy, no malignancies, including lymphoma or NMSC, have been reported.

Postmarketing Use

In global postmarketing adult and pediatric use, lymphoma and other malignancies have been reported.

5.4 Patients with Heart Failure

Two clinical trials evaluating the use of Enbrel in the treatment of heart failure were terminated early due to lack of efficacy. One of these studies suggested higher mortality in Enbrel-treated patients compared to placebo [*see Adverse Reactions (6.2)*]. There have been postmarketing reports of worsening of congestive heart failure (CHF), with and without identifiable precipitating factors, in patients taking Enbrel. There have also been rare ($< 0.1\%$) reports of new onset CHF, including CHF in patients without known preexisting cardiovascular disease. Some of these patients have been under 50 years of age. Physicians should exercise caution when using Enbrel in patients who also have heart failure, and monitor patients carefully.

5.5 Hematologic Reactions

Rare ($< 0.1\%$) reports of pancytopenia, including very rare ($< 0.01\%$) reports of aplastic anemia, some with a fatal outcome, have been reported in patients treated with Enbrel. The causal relationship to Enbrel therapy remains unclear. Although no high-risk group has been identified, caution should be exercised in patients being treated with Enbrel who have a previous history of significant hematologic abnormalities. All patients should be advised to seek immediate medical attention if they develop signs and symptoms suggestive of blood dyscrasias or infection (e.g. persistent fever, bruising, bleeding, pallor) while on Enbrel. Discontinuation of Enbrel therapy should be considered in patients with confirmed significant hematologic abnormalities.

Two percent of patients treated concurrently with Enbrel and anakinra developed neutropenia ($ANC < 1 \times 10^9/L$). While neutropenic, one patient developed cellulitis that resolved with antibiotic therapy.

5.6 Hepatitis B Reactivation

Reactivation of hepatitis B in patients who were previously infected with the hepatitis B virus (HBV) and had received concomitant TNF-blocking agents, including very rare cases ($< 0.01\%$) with Enbrel, has been reported. In some instances, hepatitis B reactivation occurring in conjunction with TNF-blocker therapy has been fatal. The majority of these reports have occurred in patients concomitantly receiving other medications that suppress the immune system, which may also contribute to hepatitis B reactivation. Patients at risk for HBV infection should be evaluated for prior evidence of HBV infection before initiating TNF-blocker therapy. Prescribers should exercise caution in prescribing TNF-blockers in patients previously infected with HBV. Adequate data are not available on the safety or efficacy of treating patients who are carriers of HBV with anti-viral therapy in conjunction with

TNF-blocker therapy to prevent HBV reactivation. Patients previously infected with HBV and requiring treatment with Enbrel should be closely monitored for clinical and laboratory signs of active HBV infection throughout therapy and for several months following termination of therapy. In patients who develop HBV reactivation, consideration should be given to stopping Enbrel and initiating anti-viral therapy with appropriate supportive treatment. The safety of resuming Enbrel therapy after HBV reactivation is controlled is not known. Therefore, prescribers should weigh the risks and benefits when considering resumption of therapy in this situation.

5.7 Allergic Reactions

Allergic reactions associated with administration of Enbrel during clinical trials have been reported in < 2% of patients. If an anaphylactic reaction or other serious allergic reaction occurs, administration of Enbrel should be discontinued immediately and appropriate therapy initiated.

Caution: The following components contain dry natural rubber (a derivative of latex), which may cause allergic reactions in individuals sensitive to latex: the needle cover of the prefilled syringe, the needle cover within the white cap of the SureClick autoinjector, and the needle cover within the purple cap of the Enbrel Mini cartridge.

5.8 Immunizations

Live vaccines should not be given concurrently with Enbrel. It is recommended that pediatric patients, if possible, be brought up-to-date with all immunizations in agreement with current immunization guidelines prior to initiating Enbrel therapy [see *Drug Interactions (7.1)* and *Use in Specific Populations (8.4)*].

5.9 Autoimmunity

Treatment with Enbrel may result in the formation of autoantibodies [see *Adverse Reactions (6.1)*] and, rarely (< 0.1%), in the development of a lupus-like syndrome or autoimmune hepatitis [see *Adverse Reactions (6.2)*], which may resolve following withdrawal of Enbrel. If a patient develops symptoms and findings suggestive of a lupus-like syndrome or autoimmune hepatitis following treatment with Enbrel, treatment should be discontinued and the patient should be carefully evaluated.

5.10 Immunosuppression

TNF mediates inflammation and modulates cellular immune responses. TNF-blocking agents, including Enbrel, affect host defenses against infections. The effect of TNF inhibition on the development and course of malignancies is not fully understood. In a study of 49 patients with RA treated with Enbrel, there was no evidence of depression of delayed-type hypersensitivity, depression of immunoglobulin levels, or change in enumeration of effector cell populations [see *Warnings and Precautions (5.1, 5.3)* and *Adverse Reactions (6.1)*].

5.11 Use in Granulomatosis with Polyangiitis Patients

The use of Enbrel in patients with granulomatosis with polyangiitis receiving immunosuppressive agents is not recommended. In a study of patients with granulomatosis with polyangiitis, the addition of Enbrel to standard therapy (including cyclophosphamide) was associated with a higher incidence of non-cutaneous solid malignancies and was not associated with improved clinical outcomes when compared with standard therapy alone [see *Drug Interactions (7.3)*].

5.12 Use with Anakinra or Abatacept

Use of Enbrel with anakinra or abatacept is not recommended [see *Drug Interactions (7.2)*].

5.13 Use in Patients with Moderate to Severe Alcoholic Hepatitis

In a study of 48 hospitalized patients treated with Enbrel or placebo for moderate to severe alcoholic hepatitis, the mortality rate in patients treated with Enbrel was similar to patients treated with placebo at 1 month but significantly

higher after 6 months. Physicians should use caution when using Enbrel in patients with moderate to severe alcoholic hepatitis.

6 ADVERSE REACTIONS

The following serious adverse reactions are discussed in greater detail in other sections of the labeling:

- Serious Infections [see *Boxed Warning and Warnings and Precautions (5.1)*]
- Neurologic Reactions [see *Warnings and Precautions (5.2)*]
- Malignancies [see *Boxed Warning and Warnings and Precautions (5.3)*]
- Patients with Heart Failure [see *Warnings and Precautions (5.4)*]
- Hematologic Reactions [see *Warnings and Precautions (5.5)*]
- Hepatitis B Reactivation [see *Warnings and Precautions (5.6)*]
- Allergic Reactions [see *Warnings and Precautions (5.7)*]
- Autoimmunity [see *Warnings and Precautions (5.9)*]
- Immunosuppression [see *Warnings and Precautions (5.10)*]

6.1 Clinical Trials Experience

Across clinical studies and postmarketing experience, the most serious adverse reactions with Enbrel were infections, neurologic events, CHF, and hematologic events [see *Warnings and Precautions (5)*]. The most common adverse reactions with Enbrel were infections and injection site reactions.

Because clinical trials are conducted under widely varying conditions, adverse reactions rates observed in the clinical trials of a drug cannot be directly compared to rates in the clinical trials of another drug and may not predict the rates observed in clinical practice.

Adverse Reactions in Adult Patients with Rheumatoid Arthritis, Psoriatic Arthritis, Ankylosing Spondylitis, or Plaque Psoriasis

The data described below reflect exposure to Enbrel in 2219 adult patients with RA followed for up to 80 months, in 182 patients with PsA for up to 24 months, in 138 patients with AS for up to 6 months, and in 1204 adult patients with PsO for up to 18 months.

In controlled trials, the proportion of Enbrel-treated patients who discontinued treatment due to adverse events was approximately 4% in the indications studied.

Adverse Reactions in Pediatric Patients

In general, the adverse reactions in pediatric patients were similar in frequency and type as those seen in adult patients [see *Warnings and Precautions (5)*, *Use in Specific Populations (8.4)*, and *Clinical Studies (14.2, 14.6)*].

In a 48-week clinical study in 211 children aged 4 to 17 years with pediatric PsO, the adverse reactions reported were similar to those seen in previous studies in adults with PsO. Long-term safety profile for up to 264 additional weeks was assessed in an open-label extension study and no new safety signals were identified.

In open-label clinical studies of children with JIA, adverse reactions reported in those ages 2 to 4 years were similar to adverse reactions reported in older children.

Infections

Infections, including viral, bacterial, and fungal infections, have been observed in adult and pediatric patients. Infections have been noted in all body systems and have been reported in patients receiving Enbrel alone or in combination with other immunosuppressive agents.

In controlled portions of trials, the types and severity of infection were similar between Enbrel and the respective control group (placebo or MTX for RA and PsA patients) in RA, PsA, AS and PsO patients. Rates of infections in

RA and adult PsO patients are provided in Table 3 and Table 4, respectively. Infections consisted primarily of upper respiratory tract infection, sinusitis and influenza.

In controlled portions of trials in RA, PsA, AS and PsO, the rates of serious infection were similar (0.8% in placebo, 3.6% in MTX, and 1.4% in Enbrel/Enbrel + MTX-treated groups). In clinical trials in rheumatologic indications, serious infections experienced by patients have included, but are not limited to, pneumonia, cellulitis, septic arthritis, bronchitis, gastroenteritis, pyelonephritis, sepsis, abscess and osteomyelitis. In clinical trials in adult PsO patients, serious infections experienced by patients have included, but are not limited to, pneumonia, cellulitis, gastroenteritis, abscess and osteomyelitis. The rate of serious infections was not increased in open-label extension trials and was similar to that observed in Enbrel- and placebo-treated patients from controlled trials.

In 66 global clinical trials of 17,505 patients (21,015 patient-years of therapy), tuberculosis was observed in approximately 0.02% of patients. In 17,696 patients (27,169 patient-years of therapy) from 38 clinical trials and 4 cohort studies in the U.S. and Canada, tuberculosis was observed in approximately 0.006% of patients. These studies include reports of pulmonary and extrapulmonary tuberculosis [see *Warnings and Precautions (5.1)*].

The types of infections reported in pediatric patients with PsO and JIA were generally mild and consistent with those commonly seen in the general pediatric population. Two JIA patients developed varicella infection and signs and symptoms of aseptic meningitis, which resolved without sequelae.

Injection Site Reactions

In placebo-controlled trials in rheumatologic indications, approximately 37% of patients treated with Enbrel developed injection site reactions. In controlled trials in patients with PsO, 15% of adult patients and 7% of pediatric patients treated with Enbrel developed injection site reactions during the first 3 months of treatment. All injection site reactions were described as mild to moderate (erythema, itching, pain, swelling, bleeding, bruising) and generally did not necessitate drug discontinuation. Injection site reactions generally occurred in the first month and subsequently decreased in frequency. The mean duration of injection site reactions was 3 to 5 days. Seven percent of patients experienced redness at a previous injection site when subsequent injections were given.

Other Adverse Reactions

Table 3 summarizes adverse reactions reported in adult RA patients. The types of adverse reactions seen in patients with PsA or AS were similar to the types of adverse reactions seen in patients with RA.

Table 3. Percent of Adult RA Patients Experiencing Adverse Reactions in Controlled Clinical Trials

| Reaction | Placebo-Controlled ^a (Studies I, II, and a Phase 2 Study) | | Active-Controlled ^b (Study III) | |
|---|---|----------------------------------|---|----------------------------------|
| | Placebo (N = 152) | Enbrel ^c (N = 349) | MTX (N = 217) | Enbrel ^c (N = 415) |
| | Percent of Patients | | Percent of Patients | |
| Infection ^d (total) | 39 | 50 | 86 | 81 |
| Upper Respiratory Infections ^e | 30 | 38 | 70 | 65 |
| Non-upper Respiratory Infections | 15 | 21 | 59 | 54 |
| Injection Site Reactions | 11 | 37 | 18 | 43 |
| Diarrhea | 9 | 8 | 16 | 16 |
| Rash | 2 | 3 | 19 | 13 |
| Pruritus | 1 | 2 | 5 | 5 |
| Pyrexia | - | 3 | 4 | 2 |
| Urticaria | 1 | - | 4 | 2 |
| Hypersensitivity | - | - | 1 | 1 |

^a Includes data from the 6-month study in which patients received concurrent MTX therapy in both arms.

^b Study duration of 2 years.

^c Any dose.

^d Includes bacterial, viral and fungal infections.

^e Most frequent Upper Respiratory Infections were upper respiratory tract infection, sinusitis and influenza.

In placebo-controlled adult PsO trials, the percentages of patients reporting adverse reactions in the 50 mg twice a week dose group were similar to those observed in the 25 mg twice a week dose group or placebo group.

Table 4 summarizes adverse reactions reported in adult PsO patients from Studies I and II.

Table 4. Percent of Adult PsO Patients Experiencing Adverse Reactions in Placebo-Controlled Portions of Clinical Trials (Studies I & II)

| Reaction | Placebo (N = 359) | Enbrel ^a (N = 876) |
|---|----------------------|----------------------------------|
| | Percent of Patients | |
| Infection ^b (total) | 28 | 27 |
| Non-upper Respiratory Infections | 14 | 12 |
| Upper Respiratory Infections ^c | 17 | 17 |
| Injection Site Reactions | 6 | 15 |
| Diarrhea | 2 | 3 |
| Rash | 1 | 1 |
| Pruritus | 2 | 1 |
| Urticaria | - | 1 |
| Hypersensitivity | - | 1 |
| Pyrexia | 1 | - |

^a Includes 25 mg subcutaneous (SC) once weekly (QW), 25 mg SC twice weekly (BIW), 50 mg SC QW, and 50 mg SC BIW doses.

^b Includes bacterial, viral and fungal infections.

^c Most frequent Upper Respiratory Infections were upper respiratory tract infection, nasopharyngitis and sinusitis.

6.2 Immunogenicity

As with all therapeutic proteins, there is potential for immunogenicity. The detection of antibody formation is highly dependent on the sensitivity and specificity of the assay. Additionally, the observed incidence of antibody (including neutralizing antibody) positivity in an assay may be influenced by several factors including assay methodology, sample handling, timing of sample collection, concomitant medications, and underlying disease. For

these reasons, comparison of the incidence of antibodies to etanercept in the studies described below with the incidence of antibodies in other studies or to other products may be misleading.

Immunogenicity

Patients with RA, PsA, AS or PsO were tested at multiple time points for antibodies to etanercept. Antibodies to the TNF receptor portion or other protein components of the Enbrel drug product were detected at least once in sera of approximately 6% of adult patients with RA, PsA, AS or PsO. These antibodies were all non-neutralizing. Results from JIA patients were similar to those seen in adult RA patients treated with Enbrel.

In adult PsO studies that evaluated the exposure of etanercept for up to 120 weeks, the percentage of patients testing positive at the assessed time points of 24, 48, 72 and 96 weeks ranged from 3.6%-8.7% and were all non-neutralizing. The percentage of patients testing positive increased with an increase in the duration of study; however, the clinical significance of this finding is unknown. No apparent correlation of antibody development to clinical response or adverse events was observed. The immunogenicity data of Enbrel beyond 120 weeks of exposure are unknown.

In pediatric PsO studies, approximately 10% of subjects developed antibodies to etanercept by Week 48 and approximately 16% of subjects developed antibodies to etanercept by Week 264. All of these antibodies were non-neutralizing. However, because of the limitations of the immunogenicity assays, the incidence of binding and neutralizing antibodies may not have been reliably determined.

The data reflect the percentage of patients whose test results were considered positive for antibodies to etanercept in an ELISA assay, and are highly dependent on the sensitivity and specificity of the assay.

Autoantibodies

Patients with RA had serum samples tested for autoantibodies at multiple time points. In RA Studies I and II, the percentage of patients evaluated for antinuclear antibodies (ANA) who developed new positive ANA (titer \geq 1:40) was higher in patients treated with Enbrel (11%) than in placebo-treated patients (5%). The percentage of patients who developed new positive anti-double-stranded DNA antibodies was also higher by radioimmunoassay (15% of patients treated with Enbrel compared to 4% of placebo-treated patients) and by *Crithidia luciliae* assay (3% of patients treated with Enbrel compared to none of placebo-treated patients). The proportion of patients treated with Enbrel who developed anticardiolipin antibodies was similarly increased compared to placebo-treated patients. In RA Study III, no pattern of increased autoantibody development was seen in Enbrel patients compared to MTX patients [see *Warnings and Precautions (5.9)*].

6.3 Postmarketing Experience

Adverse reactions have been reported during post approval use of Enbrel in adults and pediatric patients. Because these reactions are reported voluntarily from a population of uncertain size, it is not always possible to reliably estimate their frequency or establish a causal relationship to Enbrel exposure.

Adverse reactions are listed by body system below:

| | |
|---------------------------------------|--|
| Blood and lymphatic system disorders: | pancytopenia, anemia, leukopenia, neutropenia, thrombocytopenia, lymphadenopathy, aplastic anemia [see <i>Warnings and Precautions (5.5)</i>] |
| Cardiac disorders: | congestive heart failure [see <i>Warnings and Precautions (5.4)</i>] |
| Gastrointestinal disorders: | inflammatory bowel disease (IBD) |
| General disorders: | angioedema, chest pain |
| Hepatobiliary disorders: | autoimmune hepatitis, elevated transaminases, hepatitis B reactivation |
| Immune disorders: | macrophage activation syndrome, systemic vasculitis, sarcoidosis |
| Musculoskeletal and connective tissue | lupus-like syndrome |

disorders:

Neoplasms benign, malignant, and unspecified:

melanoma and non-melanoma skin cancers, Merkel cell carcinoma [see *Warnings and Precautions* (5.3)]

Nervous system disorders:

convulsions, multiple sclerosis, demyelination, optic neuritis, transverse myelitis, paresthesias, headache [see *Warnings and Precautions* (5.2)]

Ocular disorders:

uveitis, scleritis

Respiratory, thoracic and mediastinal disorders:

interstitial lung disease

Skin and subcutaneous tissue disorders:

cutaneous lupus erythematosus, cutaneous vasculitis (including leukocytoclastic vasculitis), erythema multiforme, Stevens-Johnson syndrome, toxic epidermal necrolysis, subcutaneous nodule, new or worsening psoriasis (all sub-types including pustular and palmoplantar)

Opportunistic infections, including atypical mycobacterial infection, herpes zoster, aspergillosis and *Pneumocystis jiroveci* pneumonia, and protozoal infections have also been reported in postmarketing use.

Rare (< 0.1%) cases of IBD have been reported in JIA patients receiving Enbrel, which is not effective for the treatment of IBD.

7 DRUG INTERACTIONS

Specific drug interaction studies have not been conducted with Enbrel.

7.1 Vaccines

Most PsA patients receiving Enbrel were able to mount effective B-cell immune responses to pneumococcal polysaccharide vaccine, but titers in aggregate were moderately lower and fewer patients had 2-fold rises in titers compared to patients not receiving Enbrel. The clinical significance of this is unknown. Patients receiving Enbrel may receive concurrent vaccinations, except for live vaccines. No data are available on the secondary transmission of infection by live vaccines in patients receiving Enbrel.

Patients with a significant exposure to varicella virus should temporarily discontinue Enbrel therapy and be considered for prophylactic treatment with varicella zoster immune globulin [see *Warnings and Precautions* (5.8, 5.10)].

7.2 Immune-Modulating Biologic Products

In a study in which patients with active RA were treated for up to 24 weeks with concurrent Enbrel and anakinra therapy, a 7% rate of serious infections was observed, which was higher than that observed with Enbrel alone (0%) [see *Warnings and Precautions* (5.12)] and did not result in higher ACR response rates compared to Enbrel alone. The most common infections consisted of bacterial pneumonia (4 cases) and cellulitis (4 cases). One patient with pulmonary fibrosis and pneumonia died due to respiratory failure. Two percent of patients treated concurrently with Enbrel and anakinra developed neutropenia (ANC < 1 × 10⁹/L).

In clinical studies, concurrent administration of abatacept and Enbrel resulted in increased incidences of serious adverse events, including infections, and did not demonstrate increased clinical benefit [see *Warnings and Precautions* (5.12)].

7.3 Cyclophosphamide

The use of Enbrel in patients receiving concurrent cyclophosphamide therapy is not recommended [see *Warnings and Precautions (5.11)*].

7.4 Sulfasalazine

Patients in a clinical study who were on established therapy with sulfasalazine, to which Enbrel was added, were noted to develop a mild decrease in mean neutrophil counts in comparison to groups treated with either Enbrel or sulfasalazine alone. The clinical significance of this observation is unknown.

8 USE IN SPECIFIC POPULATIONS

8.1 Pregnancy

Risk Summary

Available studies with use of etanercept during pregnancy do not reliably support an association between etanercept and major birth defects. Clinical data are available from the Organization of Teratology Information Specialists (OTIS) Enbrel Pregnancy Registry in women with rheumatic diseases or psoriasis and a Scandinavian study in pregnant women with chronic inflammatory disease. Both the OTIS Registry and the Scandinavian study showed the proportion of liveborn infants with major birth defects was higher for women exposed to etanercept compared to diseased etanercept unexposed women. However, the lack of pattern of major birth defects is reassuring and differences between exposure groups (e.g. disease severity) may have impacted the occurrence of birth defects (*see Data*). In animal reproduction studies with pregnant rats and rabbits, no fetal harm or malformations were observed with subcutaneous administration of etanercept during the period of organogenesis at doses that achieved systemic exposures 48 to 58 times the exposure in patients treated with 50 mg Enbrel once weekly (*see Data*).

All pregnancies have a background risk of birth defect, loss, or other adverse outcomes. The estimated background risk of major birth defects and miscarriage for the indicated populations is unknown. In the United States, about 2-4% of liveborn babies have a major birth defect and about 15-20% of pregnancies end in miscarriage, regardless of drug exposure.

Clinical Considerations

Fetal/Neonatal adverse reactions

The risk of fetal/neonatal adverse reactions with *in utero* exposure to Enbrel is unknown. Risks and benefits should be considered prior to administering live or live-attenuated vaccines to infants exposed to Enbrel *in utero* [see *Use in Specific Populations (8.4)*].

Data

Human Data

A prospective cohort pregnancy registry conducted by OTIS in the US and Canada between 2000 and 2012 compared the risk of major birth defects in liveborn infants of women with rheumatic diseases or psoriasis exposed to etanercept in the first trimester. The proportion of major birth defects among liveborn infants in the etanercept-exposed (N = 319) and diseased etanercept unexposed cohorts (N = 144) was 9.4% and 3.5%, respectively. The findings showed no statistically significant increased risk of minor birth defects and no pattern of major or minor birth defects.

A Scandinavian study compared the risk of major birth defects in liveborn infants of women with chronic inflammatory disease (CID) exposed to TNF-inhibitors during early pregnancy. Women were identified from the Danish (2004-2012) and Swedish (2006-2012) population based health registers. The proportion of major birth defects among liveborn infants in the etanercept-exposed (N = 344) and CID etanercept unexposed cohorts (N = 21,549) was 7.0% and 4.7%, respectively.

Overall, while both the OTIS Registry and Scandinavian study show a higher proportion of major birth defects in etanercept-exposed patients compared to diseased etanercept unexposed patients, the lack of pattern of birth defects

is reassuring and differences between exposure groups (e.g. disease severity) may have impacted the occurrence of birth defects.

Three case reports from the literature showed that cord blood levels of etanercept at delivery, in infants born to women administered etanercept during pregnancy, were between 3% and 32% of the maternal serum level.

Animal Data

In embryofetal development studies with etanercept administered during the period of organogenesis to pregnant rats from gestation day (GD) 6 through 20 or pregnant rabbits from GD 6 through 18, there was no evidence of fetal malformations or embryotoxicity in rats or rabbits at respective doses that achieved systemic exposures 48 to 58 times the exposure in patients treated with 50 mg Enbrel once weekly (on an AUC basis with maternal subcutaneous doses up to 30 mg/kg/day in rats and 40 mg/kg/day in rabbits). In a peri- and post-natal development study with pregnant rats that received etanercept during organogenesis and the later gestational period from GD 6 through 21, development of pups through post-natal day 4 was unaffected at doses that achieved exposures 48 times the exposure in patients treated with 50 mg Enbrel once weekly (on an AUC basis with maternal subcutaneous doses up to 30 mg/kg/day).

8.2 Lactation

Risk Summary

Limited data from published literature show that etanercept is present in low levels in human milk and minimally absorbed by a breastfed infant. No data are available on the effects of etanercept on the breastfed child or the effects on milk production. The developmental and health benefits of breastfeeding should be considered along with the mother's clinical need for Enbrel and any potential adverse effects on the breastfed child from the drug or from the underlying maternal condition.

8.4 Pediatric Use

Enbrel has been studied in 69 children with moderately to severely active polyarticular JIA aged 2 to 17 years.

Enbrel has been studied in 211 pediatric patients with moderate to severe PsO aged 4 to 17 years.

Enbrel has not been studied in children < 2 years of age with JIA and < 4 years of age with PsO. For pediatric specific safety information concerning malignancies and inflammatory bowel disease [*see Warnings and Precautions (5.3) and Adverse Reactions (6.2)*].

The clinical significance of infant exposure to Enbrel *in utero* is unknown. The safety of administering live or live-attenuated vaccines in exposed infants is unknown. Risks and benefits should be considered prior to administering live or live-attenuated vaccines to exposed infants. For pediatric specific safety information concerning vaccinations [*see Warnings and Precautions (5.8) and Drug Interactions (7.1)*].

8.5 Geriatric Use

A total of 480 RA patients ages 65 years or older have been studied in clinical trials. In PsO randomized clinical trials, a total of 138 out of 1965 patients treated with Enbrel or placebo were age 65 or older. No overall differences in safety or effectiveness were observed between these patients and younger patients, but the number of geriatric PsO patients is too small to determine whether they respond differently from younger patients. Because there is a higher incidence of infections in the elderly population in general, caution should be used in treating the elderly.

8.6 Use in Diabetics

There have been reports of hypoglycemia following initiation of Enbrel therapy in patients receiving medication for diabetes, necessitating a reduction in anti-diabetic medication in some of these patients.

10 OVERDOSAGE

No dose-limiting toxicities have been observed during clinical trials of Enbrel. Single IV doses up to 60 mg/m² (approximately twice the recommended dose) have been administered to healthy volunteers in an endotoxemia study without evidence of dose-limiting toxicities.

11 DESCRIPTION

Etanercept, a tumor necrosis factor (TNF) blocker, is a dimeric fusion protein consisting of the extracellular ligand-binding portion of the human 75 kilodalton (p75) tumor necrosis factor receptor (TNFR) linked to the Fc portion of human IgG1. The Fc component of etanercept contains the C_H2 domain, the C_H3 domain and hinge region, but not the C_H1 domain of IgG1. Etanercept is produced by recombinant DNA technology in a Chinese hamster ovary (CHO) mammalian cell expression system. It consists of 934 amino acids and has an apparent molecular weight of approximately 150 kilodaltons.

Enbrel (etanercept) Injection in the single-dose prefilled syringe, the single-dose prefilled SureClick autoinjector and the single-dose vial is clear and colorless, sterile, preservative-free solution, and is formulated at pH 6.3 ± 0.2.

Enbrel (etanercept) for Injection is supplied in a multiple-dose vial as a sterile, white, preservative-free, lyophilized powder. Reconstitution with 1 mL of the supplied Sterile Bacteriostatic Water for Injection, USP (containing 0.9% benzyl alcohol) yields a multiple-dose, clear, and colorless solution 1 mL containing 25 mg of Enbrel, with a pH of 7.4 ± 0.3.

Enbrel (etanercept) Injection in the Enbrel Mini single-dose prefilled cartridge for use with the AutoTouch reusable autoinjector is clear and colorless, sterile, preservative-free solution, and is formulated at pH 6.3 ± 0.2.

Table 5. Contents of Enbrel

| Presentation | Active Ingredient Content | Inactive Ingredients Content |
|--|--|--|
| Enbrel 50 mg prefilled syringe and SureClick autoinjector | 50 mg etanercept in 1 mL | 25 mM L-arginine hydrochloride 120 mM sodium chloride 1% sucrose |
| Enbrel 25 mg prefilled syringe | 25 mg etanercept in 0.5 mL | 25 mM L-arginine hydrochloride 120 mM sodium chloride 1% sucrose |
| Enbrel 25 mg single-dose vial | 25 mg etanercept in 0.5 mL | 25 mM L-arginine hydrochloride 120 mM sodium chloride 1% sucrose |
| Enbrel 25 mg multiple-dose vial | After reconstitution, 25 mg etanercept in 1 mL | 40 mg mannitol 10 mg sucrose 1.2 mg tromethamine |
| Enbrel 50 mg Enbrel Mini single-dose prefilled cartridge for use with the AutoTouch reusable autoinjector only | 50 mg etanercept in 1 mL | 25 mM L-arginine hydrochloride 120 mM sodium chloride 1% sucrose |

12 CLINICAL PHARMACOLOGY

12.1 Mechanism of Action

TNF is a naturally occurring cytokine that is involved in normal inflammatory and immune responses. It plays an important role in the inflammatory processes of RA, polyarticular JIA, PsA, and AS and the resulting joint

pathology. In addition, TNF plays a role in the inflammatory process of PsO. Elevated levels of TNF are found in involved tissues and fluids of patients with RA, JIA, PsA, AS, and PsO.

Two distinct receptors for TNF (TNFRs), a 55 kilodalton protein (p55) and a 75 kilodalton protein (p75), exist naturally as monomeric molecules on cell surfaces and in soluble forms. Biological activity of TNF is dependent upon binding to either cell surface TNFR.

Etanercept is a dimeric soluble form of the p75 TNF receptor that can bind TNF molecules. Etanercept inhibits binding of TNF- α and TNF- β (lymphotoxin alpha [LT- α]) to cell surface TNFRs, rendering TNF biologically inactive. In *in vitro* studies, large complexes of etanercept with TNF- α were not detected and cells expressing transmembrane TNF (that binds Enbrel) are not lysed in the presence or absence of complement.

12.2 Pharmacodynamics

Etanercept can modulate biological responses that are induced or regulated by TNF, including expression of adhesion molecules responsible for leukocyte migration (e.g. E-selectin, and to a lesser extent, intercellular adhesion molecule-1 [ICAM-1]), serum levels of cytokines (e.g. IL-6), and serum levels of matrix metalloproteinase-3 (MMP-3 or stromelysin). Etanercept has been shown to affect several animal models of inflammation, including murine collagen-induced arthritis.

12.3 Pharmacokinetics

After administration of 25 mg of Enbrel by a single SC injection to 25 patients with RA, a mean \pm standard deviation half-life of 102 ± 30 hours was observed with a clearance of 160 ± 80 mL/hr. A maximum serum concentration (C_{\max}) of 1.1 ± 0.6 mcg/mL and time to C_{\max} of 69 ± 34 hours was observed in these patients following a single 25 mg dose. After 6 months of twice weekly 25 mg doses in these same RA patients, the mean C_{\max} was 2.4 ± 1.0 mcg/mL ($N = 23$). Patients exhibited a 2- to 7-fold increase in peak serum concentrations and approximately 4-fold increase in $AUC_{0-72 \text{ hr}}$ (range 1- to 17-fold) with repeated dosing. Serum concentrations in patients with RA have not been measured for periods of dosing that exceed 6 months.

In another study, serum concentration profiles at steady-state were comparable among patients with RA treated with 50 mg Enbrel once weekly and those treated with 25 mg Enbrel twice weekly. The mean (\pm standard deviation) C_{\max} , C_{\min} , and partial AUC were 2.4 ± 1.5 mcg/mL, 1.2 ± 0.7 mcg/mL, and 297 ± 166 mcg•h/mL, respectively, for patients treated with 50 mg Enbrel once weekly ($N = 21$); and 2.6 ± 1.2 mcg/mL, 1.4 ± 0.7 mcg/mL, and 316 ± 135 mcg•h/mL for patients treated with 25 mg Enbrel twice weekly ($N = 16$).

Patients with JIA (ages 4 to 17 years) were administered 0.4 mg/kg of Enbrel twice weekly (up to a maximum dose of 50 mg per week) for up to 18 weeks. The mean serum concentration after repeated SC dosing was 2.1 mcg/mL, with a range of 0.7 to 4.3 mcg/mL. Limited data suggest that the clearance of etanercept is reduced slightly in children ages 4 to 8 years. Population pharmacokinetic analyses predict that the pharmacokinetic differences between the regimens of 0.4 mg/kg twice weekly and 0.8 mg/kg once weekly in JIA patients are of the same magnitude as the differences observed between twice weekly and weekly regimens in adult RA patients.

The mean (\pm SD) serum steady-state trough concentrations for the 50 mg QW dosing in adult PsO subjects were 1.5 ± 0.7 mcg/mL. Pediatric PsO patients (age 4 to 17 years) were administered 0.8 mg/kg of Enbrel once weekly (up to a maximum dose of 50 mg per week) for up to 48 weeks. The mean (\pm SD) serum steady-state trough concentrations ranged from 1.6 ± 0.8 to 2.1 ± 1.3 mcg/mL at weeks 12, 24, and 48.

In clinical studies with Enbrel, pharmacokinetic parameters were not different between men and women and did not vary with age in adult patients. The pharmacokinetics of etanercept were unaltered by concomitant MTX in RA patients. No formal pharmacokinetic studies have been conducted to examine the effects of renal or hepatic impairment on etanercept disposition.

13 NONCLINICAL TOXICOLOGY

13.1 Carcinogenesis, Mutagenesis, Impairment of Fertility

Long-term animal studies have not been conducted to evaluate the carcinogenic potential of etanercept or its effect on fertility.

14 CLINICAL STUDIES

14.1 Adult Rheumatoid Arthritis

The safety and efficacy of Enbrel were assessed in four randomized, double-blind, controlled studies. The results of all four trials were expressed in percentage of patients with improvement in RA using ACR response criteria.

Study I evaluated 234 patients with active RA who were ≥ 18 years old, had failed therapy with at least one but no more than four disease-modifying antirheumatic drugs (DMARDs) (e.g. hydroxychloroquine, oral or injectable gold, MTX, azathioprine, D-penicillamine, sulfasalazine), and had ≥ 12 tender joints, ≥ 10 swollen joints, and either erythrocyte sedimentation rate (ESR) ≥ 28 mm/hr, C-reactive protein (CRP) > 2.0 mg/dL, or morning stiffness for ≥ 45 minutes. Doses of 10 mg or 25 mg Enbrel or placebo were administered SC twice a week for 6 consecutive months.

Study II evaluated 89 patients and had similar inclusion criteria to Study I except that patients in Study II had additionally received MTX for at least 6 months with a stable dose (12.5 to 25 mg/week) for at least 4 weeks and they had at least 6 tender or painful joints. Patients in Study II received a dose of 25 mg Enbrel or placebo SC twice a week for 6 months in addition to their stable MTX dose.

Study III compared the efficacy of Enbrel to MTX in patients with active RA. This study evaluated 632 patients who were ≥ 18 years old with early (≤ 3 years disease duration) active RA, had never received treatment with MTX, and had ≥ 12 tender joints, ≥ 10 swollen joints, and either ESR ≥ 28 mm/hr, CRP > 2.0 mg/dL, or morning stiffness for ≥ 45 minutes. Doses of 10 mg or 25 mg Enbrel were administered SC twice a week for 12 consecutive months. The study was unblinded after all patients had completed at least 12 months (and a median of 17.3 months) of therapy. The majority of patients remained in the study on the treatment to which they were randomized through 2 years, after which they entered an extension study and received open-label 25 mg Enbrel. MTX tablets (escalated from 7.5 mg/week to a maximum of 20 mg/week over the first 8 weeks of the trial) or placebo tablets were given once a week on the same day as the injection of placebo or Enbrel doses, respectively.

Study IV evaluated 682 adult patients with active RA of 6 months to 20 years duration (mean of 7 years) who had an inadequate response to at least one DMARD other than MTX. Forty-three percent of patients had previously received MTX for a mean of 2 years prior to the trial at a mean dose of 12.9 mg. Patients were excluded from this study if MTX had been discontinued for lack of efficacy or for safety considerations. The patient baseline characteristics were similar to those of patients in Study I. Patients were randomized to MTX alone (7.5 to 20 mg weekly, dose escalated as described for Study III; median dose 20 mg), Enbrel alone (25 mg twice weekly), or the combination of Enbrel and MTX initiated concurrently (at the same doses as above). The study evaluated ACR response, Sharp radiographic score, and safety.

Clinical Response

A higher percentage of patients treated with Enbrel and Enbrel in combination with MTX achieved ACR 20, ACR 50, and ACR 70 responses and Major Clinical Responses than in the comparison groups. The results of Studies I, II, and III are summarized in Table 6. The results of Study IV are summarized in Table 7.

**Table 6. ACR Responses in Placebo- and Active-Controlled Trials
(Percent of Patients)**

| Response | Placebo-Controlled | | | | Active-Controlled | |
|---------------|--------------------|-------------------------------|-----------------------|-----------------------------------|-------------------|--------------------------------|
| | Study I | | Study II | | Study III | |
| | Placebo N = 80 | Enbrel ^a N = 78 | MTX/Placebo N = 30 | MTX/Enbrel ^a N = 59 | MTX N = 217 | Enbrel ^a N = 207 |
| ACR 20 | | | | | | |
| Month 3 | 23% | 62% ^b | 33% | 66% ^b | 56% | 62% |
| Month 6 | 11% | 59% ^b | 27% | 71% ^b | 58% | 65% |
| Month 12 | NA | NA | NA | NA | 65% | 72% |
| ACR 50 | | | | | | |
| Month 3 | 8% | 41% ^b | 0% | 42% ^b | 24% | 29% |
| Month 6 | 5% | 40% ^b | 3% | 39% ^b | 32% | 40% |
| Month 12 | NA | NA | NA | NA | 43% | 49% |
| ACR 70 | | | | | | |
| Month 3 | 4% | 15% ^b | 0% | 15% ^b | 7% | 13% ^c |
| Month 6 | 1% | 15% ^b | 0% | 15% ^b | 14% | 21% ^c |
| Month 12 | NA | NA | NA | NA | 22% | 25% |

^a 25 mg Enbrel SC twice weekly.

^b $p < 0.01$, Enbrel versus placebo.

^c $p < 0.05$, Enbrel versus MTX.

Table 7. Study IV Clinical Efficacy Results: Comparison of MTX versus Enbrel versus Enbrel in Combination with MTX in Patients with Rheumatoid Arthritis of 6 Months to 20 Years Duration (Percent of Patients)

| Endpoint | MTX (N = 228) | Enbrel (N = 223) | Enbrel/MTX (N = 231) |
|--|------------------|---------------------|-------------------------|
| ACR N^{a, b} | | | |
| Month 12 | 40% | 47% | 63% ^c |
| ACR 20 | | | |
| Month 12 | 59% | 66% | 75% ^c |
| ACR 50 | | | |
| Month 12 | 36% | 43% | 63% ^c |
| ACR 70 | | | |
| Month 12 | 17% | 22% | 40% ^c |
| Major Clinical Response^d | 6% | 10% | 24% ^c |

^a Values are medians.

^b ACR N is the percent improvement based on the same core variables used in defining ACR 20, ACR 50, and ACR 70.

^c $p < 0.05$ for comparisons of Enbrel/MTX versus Enbrel alone or MTX alone.

^d Major clinical response is achieving an ACR 70 response for a continuous 6-month period.

The time course for ACR 20 response rates for patients receiving placebo or 25 mg Enbrel in Studies I and II is summarized in Figure 1. The time course of responses to Enbrel in Study III was similar.

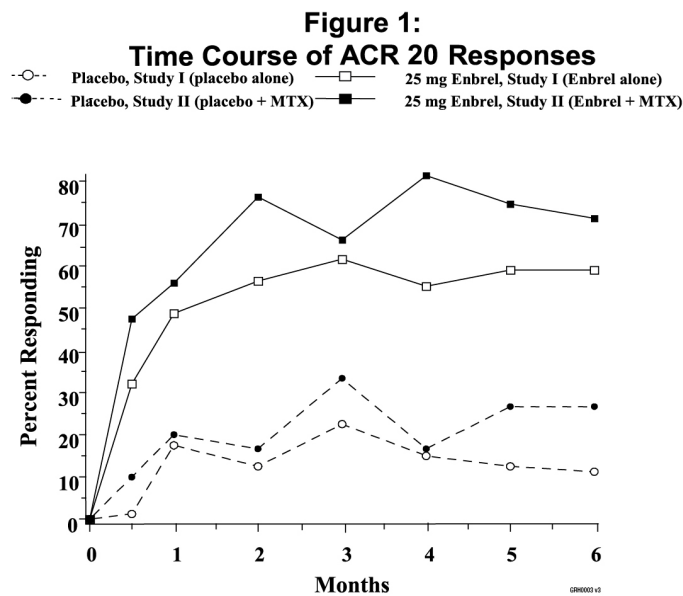

Among patients receiving Enbrel, the clinical responses generally appeared within 1 to 2 weeks after initiation of therapy and nearly always occurred by 3 months. A dose response was seen in Studies I and III: 25 mg Enbrel was more effective than 10 mg (10 mg was not evaluated in Study II). Enbrel was significantly better than placebo in all components of the ACR criteria as well as other measures of RA disease activity not included in the ACR response criteria, such as morning stiffness.

In Study III, ACR response rates and improvement in all the individual ACR response criteria were maintained through 24 months of Enbrel therapy. Over the 2-year study, 23% of Enbrel patients achieved a major clinical response, defined as maintenance of an ACR 70 response over a 6-month period.

The results of the components of the ACR response criteria for Study I are shown in Table 8. Similar results were observed for Enbrel-treated patients in Studies II and III.

Table 8. Components of ACR Response in Study I

| Parameter (median) | Placebo N = 80 | | Enbrel ^a N = 78 | |
|--|-------------------|----------|-------------------------------|-----------------------|
| | Baseline | 3 Months | Baseline | 3 Months [*] |
| Number of tender joints ^b | 34.0 | 29.5 | 31.2 | 10.0 ^f |
| Number of swollen joints ^c | 24.0 | 22.0 | 23.5 | 12.6 ^f |
| Physician global assessment ^d | 7.0 | 6.5 | 7.0 | 3.0 ^f |
| Patient global assessment ^d | 7.0 | 7.0 | 7.0 | 3.0 ^f |
| Pain ^d | 6.9 | 6.6 | 6.9 | 2.4 ^f |
| Disability index ^e | 1.7 | 1.8 | 1.6 | 1.0 ^f |
| ESR (mm/hr) | 31.0 | 32.0 | 28.0 | 15.5 ^f |
| CRP (mg/dL) | 2.8 | 3.9 | 3.5 | 0.9 ^f |

^{*} Results at 6 months showed similar improvement.

^a 25 mg Enbrel SC twice weekly.

^b Scale 0-71.

^c Scale 0-68.

^d Visual analog scale: 0 = best; 10 = worst.

^e Health Assessment Questionnaire: 0 = best; 3 = worst; includes eight categories: dressing and grooming, arising, eating, walking, hygiene, reach, grip, and activities.

^f p < 0.01, Enbrel versus placebo, based on mean percent change from baseline.

After discontinuation of Enbrel, symptoms of arthritis generally returned within a month. Reintroduction of treatment with Enbrel after discontinuations of up to 18 months resulted in the same magnitudes of response as in patients who received Enbrel without interruption of therapy, based on results of open-label studies.

Continued durable responses were seen for over 60 months in open-label extension treatment trials when patients received Enbrel without interruption. A substantial number of patients who initially received concomitant MTX or corticosteroids were able to reduce their doses or discontinue these concomitant therapies while maintaining their clinical responses.

Physical Function Response

In Studies I, II, and III, physical function and disability were assessed using the Health Assessment Questionnaire (HAQ). Additionally, in Study III, patients were administered the SF-36 Health Survey. In Studies I and II, patients treated with 25 mg Enbrel twice weekly showed greater improvement from baseline in the HAQ score beginning in month 1 through month 6 in comparison to placebo ($p < 0.001$) for the HAQ disability domain (where 0 = none and 3 = severe). In Study I, the mean improvement in the HAQ score from baseline to month 6 was 0.6 (from 1.6 to 1.0) for the 25 mg Enbrel group and 0 (from 1.7 to 1.7) for the placebo group. In Study II, the mean improvement from baseline to month 6 was 0.6 (from 1.5 to 0.9) for the Enbrel/MTX group and 0.2 (from 1.3 to 1.2) for the placebo/MTX group. In Study III, the mean improvement in the HAQ score from baseline to month 6 was 0.7 (from 1.5 to 0.7) for 25 mg Enbrel twice weekly. All subdomains of the HAQ in Studies I and III were improved in patients treated with Enbrel.

In Study III, patients treated with 25 mg Enbrel twice weekly showed greater improvement from baseline in SF-36 physical component summary score compared to Enbrel 10 mg twice weekly and no worsening in the SF-36 mental component summary score. In open-label Enbrel studies, improvements in physical function and disability measures have been maintained for up to 4 years.

In Study IV, median HAQ scores improved from baseline levels of 1.8, 1.8, and 1.8 to 1.1, 1.0, and 0.6 at 12 months in the MTX, Enbrel, and Enbrel/MTX combination treatment groups, respectively (combination versus both MTX and Enbrel, $p < 0.01$). Twenty-nine percent of patients in the MTX alone treatment group had an improvement of HAQ of at least 1 unit versus 40% and 51% in the Enbrel alone and the Enbrel/MTX combination treatment groups, respectively.

Radiographic Response

In Study III, structural joint damage was assessed radiographically and expressed as change in Total Sharp Score (TSS) and its components, the erosion score and Joint Space Narrowing (JSN) score. Radiographs of hands/wrists and forefeet were obtained at baseline, 6 months, 12 months, and 24 months and scored by readers who were unaware of treatment group. The results are shown in Table 9. A significant difference for change in erosion score was observed at 6 months and maintained at 12 months.

Table 9. Mean Radiographic Change Over 6 and 12 Months in Study III

| | | MTX | 25 mg Enbrel | MTX/Enbrel (95% Confidence Interval*) | P Value |
|-----------|-------------------|------|--------------|--|---------|
| 12 Months | Total Sharp Score | 1.59 | 1.00 | 0.59 (-0.12, 1.30) | 0.1 |
| | Erosion Score | 1.03 | 0.47 | 0.56 (0.11, 1.00) | 0.002 |
| | JSN Score | 0.56 | 0.52 | 0.04 (-0.39, 0.46) | 0.5 |
| 6 Months | Total Sharp Score | 1.06 | 0.57 | 0.49 (0.06, 0.91) | 0.001 |
| | Erosion Score | 0.68 | 0.30 | 0.38 (0.09, 0.66) | 0.001 |
| | JSN Score | 0.38 | 0.27 | 0.11 (-0.14, 0.35) | 0.6 |

* 95% confidence intervals for the differences in change scores between MTX and Enbrel.

Patients continued on the therapy to which they were randomized for the second year of Study III. Seventy-two percent of patients had x-rays obtained at 24 months. Compared to the patients in the MTX group, greater inhibition

of progression in TSS and erosion score was seen in the 25 mg Enbrel group, and, in addition, less progression was noted in the JSN score.

In the open-label extension of Study III, 48% of the original patients treated with 25 mg Enbrel have been evaluated radiographically at 5 years. Patients had continued inhibition of structural damage, as measured by the TSS, and 55% of them had no progression of structural damage. Patients originally treated with MTX had further reduction in radiographic progression once they began treatment with Enbrel.

In Study IV, less radiographic progression (TSS) was observed with Enbrel in combination with MTX compared with Enbrel alone or MTX alone at month 12 (Table 10). In the MTX treatment group, 55% of patients experienced no radiographic progression (TSS change ≤ 0.0) at 12 months compared to 63% and 76% in the Enbrel alone and the Enbrel/MTX combination treatment groups, respectively.

Table 10. Mean Radiographic Change in Study IV at 12 Months (95% Confidence Interval)

| | MTX (N = 212)* | Enbrel (N = 212)* | Enbrel/MTX (N = 218)* |
|-----------------------------------|----------------------|------------------------------------|--|
| Total Sharp Score (TSS) | 2.80 (1.08, 4.51) | 0.52 ^a (-0.10, 1.15) | -0.54 ^{b,c} (-1.00, -0.07) |
| Erosion Score (ES) | 1.68 (0.61, 2.74) | 0.21 ^a (-0.20, 0.61) | -0.30 ^b (-0.65, 0.04) |
| Joint Space Narrowing (JSN) Score | 1.12 (0.34, 1.90) | 0.32 (0.00, 0.63) | -0.23 ^{b,c} (-0.45, -0.02) |

* Analyzed radiographic ITT population.

^a p < 0.05 for comparison of Enbrel versus MTX.

^b p < 0.05 for comparison of Enbrel/MTX versus MTX.

^c p < 0.05 for comparison of Enbrel/MTX versus Enbrel.

Once Weekly Dosing

The safety and efficacy of 50 mg Enbrel (two 25 mg SC injections) administered once weekly were evaluated in a double-blind, placebo-controlled study of 420 patients with active RA. Fifty-three patients received placebo, 214 patients received 50 mg Enbrel once weekly, and 153 patients received 25 mg Enbrel twice weekly. The safety and efficacy profiles of the two Enbrel treatment groups were similar.

14.2 Polyarticular Juvenile Idiopathic Arthritis (JIA)

The safety and efficacy of Enbrel were assessed in a 2-part study in 69 children with polyarticular JIA who had a variety of JIA onset types. Patients ages 2 to 17 years with moderately to severely active polyarticular JIA refractory to or intolerant of MTX were enrolled; patients remained on a stable dose of a single nonsteroidal anti-inflammatory drug and/or prednisone (≤ 0.2 mg/kg/day or 10 mg maximum). In part 1, all patients received 0.4 mg/kg (maximum 25 mg per dose) Enbrel SC twice weekly. In part 2, patients with a clinical response at day 90 were randomized to remain on Enbrel or receive placebo for 4 months and assessed for disease flare. Responses were measured using the JIA Definition of Improvement (DOI), defined as $\geq 30\%$ improvement in at least three of six and $\geq 30\%$ worsening in no more than one of the six JIA core set criteria, including active joint count, limitation of motion, physician and patient/parent global assessments, functional assessment, and ESR. Disease flare was defined as a $\geq 30\%$ worsening in three of the six JIA core set criteria and $\geq 30\%$ improvement in not more than one of the six JIA core set criteria and a minimum of two active joints.

In part 1 of the study, 51 of 69 (74%) patients demonstrated a clinical response and entered part 2. In part 2, 6 of 25 (24%) patients remaining on Enbrel experienced a disease flare compared to 20 of 26 (77%) patients receiving placebo (p = 0.007). From the start of part 2, the median time to flare was ≥ 116 days for patients who received Enbrel and 28 days for patients who received placebo. Each component of the JIA core set criteria worsened in the arm that received placebo and remained stable or improved in the arm that continued on Enbrel. The data suggested the possibility of a higher flare rate among those patients with a higher baseline ESR. Of patients who demonstrated

a clinical response at 90 days and entered part 2 of the study, some of the patients remaining on Enbrel continued to improve from month 3 through month 7, while those who received placebo did not improve.

The majority of JIA patients who developed a disease flare in part 2 and reintroduced Enbrel treatment up to 4 months after discontinuation re-responded to Enbrel therapy in open-label studies. Most of the responding patients who continued Enbrel therapy without interruption have maintained responses for up to 48 months.

Studies have not been done in patients with polyarticular JIA to assess the effects of continued Enbrel therapy in patients who do not respond within 3 months of initiating Enbrel therapy, or to assess the combination of Enbrel with MTX.

14.3 Psoriatic Arthritis

The safety and efficacy of Enbrel were assessed in a randomized, double-blind, placebo-controlled study in 205 patients with PsA. Patients were between 18 and 70 years of age and had active PsA (≥ 3 swollen joints and ≥ 3 tender joints) in one or more of the following forms: (1) distal interphalangeal (DIP) involvement (N = 104); (2) polyarticular arthritis (absence of rheumatoid nodules and presence of psoriasis; N = 173); (3) arthritis mutilans (N = 3); (4) asymmetric psoriatic arthritis (N = 81); or (5) ankylosing spondylitis-like (N = 7). Patients also had plaque psoriasis with a qualifying target lesion ≥ 2 cm in diameter. Patients on MTX therapy at enrollment (stable for ≥ 2 months) could continue at a stable dose of ≤ 25 mg/week MTX. Doses of 25 mg Enbrel or placebo were administered SC twice a week during the initial 6-month double-blind period of the study. Patients continued to receive blinded therapy in an up to 6-month maintenance period until all patients had completed the controlled period. Following this, patients received open-label 25 mg Enbrel twice a week in a 12-month extension period.

Compared to placebo, treatment with Enbrel resulted in significant improvements in measures of disease activity (Table 11).

Table 11. Components of Disease Activity in Psoriatic Arthritis

| Parameter (median) | Placebo N = 104 | | Enbrel ^a N = 101 | |
|--|--------------------|----------|--------------------------------|----------|
| | Baseline | 6 Months | Baseline | 6 Months |
| Number of tender joints ^b | 17.0 | 13.0 | 18.0 | 5.0 |
| Number of swollen joints ^c | 12.5 | 9.5 | 13.0 | 5.0 |
| Physician global assessment ^d | 3.0 | 3.0 | 3.0 | 1.0 |
| Patient global assessment ^d | 3.0 | 3.0 | 3.0 | 1.0 |
| Morning stiffness (minutes) | 60 | 60 | 60 | 15 |
| Pain ^d | 3.0 | 3.0 | 3.0 | 1.0 |
| Disability index ^e | 1.0 | 0.9 | 1.1 | 0.3 |
| CRP (mg/dL) ^f | 1.1 | 1.1 | 1.6 | 0.2 |

^a $p < 0.001$ for all comparisons between Enbrel and placebo at 6 months.

^b Scale 0-78.

^c Scale 0-76.

^d Likert scale: 0 = best; 5 = worst.

^e Health Assessment Questionnaire: 0 = best; 3 = worst; includes eight categories: dressing and grooming, arising, eating, walking, hygiene, reach, grip, and activities.

^f Normal range: 0-0.79 mg/dL.

Among patients with PsA who received Enbrel, the clinical responses were apparent at the time of the first visit (4 weeks) and were maintained through 6 months of therapy. Responses were similar in patients who were or were not receiving concomitant MTX therapy at baseline. At 6 months, the ACR 20/50/70 responses were achieved by 50%, 37%, and 9%, respectively, of patients receiving Enbrel, compared to 13%, 4%, and 1%, respectively, of patients receiving placebo. Similar responses were seen in patients with each of the subtypes of PsA, although few patients were enrolled with the arthritis mutilans and ankylosing spondylitis-like subtypes. The results of this study were similar to those seen in an earlier single-center, randomized, placebo-controlled study of 60 patients with PsA.

The skin lesions of psoriasis were also improved with Enbrel, relative to placebo, as measured by percentages of patients achieving improvements in the Psoriasis Area and Severity Index (PASI). Responses increased over time, and at 6 months, the proportions of patients achieving a 50% or 75% improvement in the PASI were 47% and 23%, respectively, in the Enbrel group (N = 66), compared to 18% and 3%, respectively, in the placebo group (N = 62). Responses were similar in patients who were or were not receiving concomitant MTX therapy at baseline.

Radiographic Response

Radiographic changes were also assessed in the PsA study. Radiographs of hands and wrists were obtained at baseline and months 6, 12, and 24. A modified Total Sharp Score (TSS), which included distal interphalangeal joints (i.e., not identical to the modified TSS used for RA) was used by readers blinded to treatment group to assess the radiographs. Some radiographic features specific to PsA (e.g. pencil-and-cup deformity, joint space widening, gross osteolysis, and ankylosis) were included in the scoring system, but others (e.g. phalangeal tuft resorption, juxta-articular and shaft periostitis) were not.

Most patients showed little or no change in the modified TSS during this 24-month study (median change of 0 in both patients who initially received Enbrel or placebo). More placebo-treated patients experienced larger magnitudes of radiographic worsening (increased TSS) compared to Enbrel treatment during the controlled period of the study. At 12 months, in an exploratory analysis, 12% (12 of 104) of placebo patients compared to none of the 101 Enbrel-treated patients had increases of 3 points or more in TSS. Inhibition of radiographic progression was maintained in patients who continued on Enbrel during the second year. Of the patients with 1-year and 2-year x-rays, 3% (2 of 71) had increases of 3 points or more in TSS at 1 and 2 years.

Physical Function Response

In the PsA study, physical function and disability were assessed using the HAQ Disability Index (HAQ-DI) and the SF-36 Health Survey. Patients treated with 25 mg Enbrel twice weekly showed greater improvement from baseline in the HAQ-DI score (mean decreases of 54% at both months 3 and 6) in comparison to placebo (mean decreases of 6% at both months 3 and 6) ($p < 0.001$). At months 3 and 6, patients treated with Enbrel showed greater improvement from baseline in the SF-36 physical component summary score compared to patients treated with placebo, and no worsening in the SF-36 mental component summary score. Improvements in physical function and disability measures were maintained for up to 2 years through the open-label portion of the study.

14.4 Ankylosing Spondylitis

The safety and efficacy of Enbrel were assessed in a randomized, double-blind, placebo-controlled study in 277 patients with active AS. Patients were between 18 and 70 years of age and had AS as defined by the modified New York Criteria for Ankylosing Spondylitis. Patients were to have evidence of active disease based on values of ≥ 30 on a 0-100 unit Visual Analog Scale (VAS) for the average of morning stiffness duration and intensity, and two of the following three other parameters: a) patient global assessment, b) average of nocturnal and total back pain, and c) the average score on the Bath Ankylosing Spondylitis Functional Index (BASFI). Patients with complete ankylosis of the spine were excluded from study participation. Patients taking hydroxychloroquine, sulfasalazine, methotrexate, or prednisone (≤ 10 mg/day) could continue these drugs at stable doses for the duration of the study. Doses of 25 mg Enbrel or placebo were administered SC twice a week for 6 months.

The primary measure of efficacy was a 20% improvement in the Assessment in Ankylosing Spondylitis (ASAS) response criteria. Compared to placebo, treatment with Enbrel resulted in improvements in the ASAS and other measures of disease activity (Figure 2 and Table 12).

Figure 2. ASAS 20 Responses in Ankylosing Spondylitis

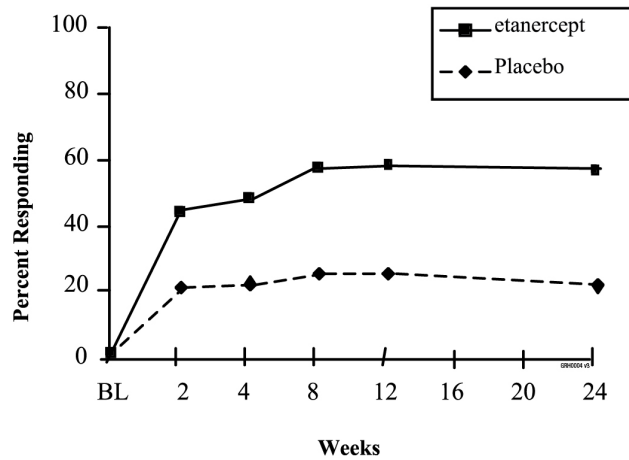

At 12 weeks, the ASAS 20/50/70 responses were achieved by 60%, 45%, and 29%, respectively, of patients receiving Enbrel, compared to 27%, 13%, and 7%, respectively, of patients receiving placebo ($p \leq 0.0001$, Enbrel versus placebo). Similar responses were seen at Week 24. Responses were similar between those patients receiving concomitant therapies at baseline and those who were not. The results of this study were similar to those seen in a single-center, randomized, placebo-controlled study of 40 patients and a multicenter, randomized, placebo-controlled study of 84 patients with AS.

Table 12. Components of Ankylosing Spondylitis Disease Activity

| Median values at time points | Placebo N = 139 | | Enbrel ^a N = 138 | |
|--|--------------------|----------|--------------------------------|----------|
| | Baseline | 6 Months | Baseline | 6 Months |
| ASAS response criteria | | | | |
| Patient global assessment ^b | 63 | 56 | 63 | 36 |
| Back pain ^c | 62 | 56 | 60 | 34 |
| BASFI ^d | 56 | 55 | 52 | 36 |
| Inflammation ^e | 64 | 57 | 61 | 33 |
| Acute phase reactants | | | | |
| CRP (mg/dL) ^f | 2.0 | 1.9 | 1.9 | 0.6 |
| Spinal mobility (cm): | | | | |
| Modified Schober's test | 3.0 | 2.9 | 3.1 | 3.3 |
| Chest expansion | 3.2 | 3.0 | 3.3 | 3.9 |
| Occiput-to-wall measurement | 5.3 | 6.0 | 5.6 | 4.5 |

^a $p < 0.0015$ for all comparisons between Enbrel and placebo at 6 months. P values for continuous endpoints were based on percent change from baseline.

^b Measured on a Visual Analog Scale (VAS) with 0 = "none" and 100 = "severe".

^c Average of total nocturnal and back pain scores, measured on a VAS with 0 = "no pain" and 100 = "most severe pain".

^d Bath Ankylosing Spondylitis Functional Index (BASFI), average of 10 questions.

^e Inflammation represented by the average of the last 2 questions on the 6-question Bath Ankylosing Spondylitis Disease Activity Index (BASDAI).

^f C-reactive protein (CRP) normal range: 0-1.0 mg/dL.

14.5 Adult Plaque Psoriasis

The safety and efficacy of Enbrel were assessed in two randomized, double-blind, placebo-controlled studies in adults with chronic stable PsO involving $\geq 10\%$ of the body surface area, a minimum Psoriasis Area and Severity Index (PASI) score of 10 and who had received or were candidates for systemic antipsoriatic therapy or phototherapy. Patients with guttate, erythrodermic, or pustular psoriasis and patients with severe infections within 4 weeks of screening were excluded from study. No concomitant major antipsoriatic therapies were allowed during the study.

Study I evaluated 672 subjects who received placebo or Enbrel SC at doses of 25 mg once a week, 25 mg twice a week, or 50 mg twice a week for 3 months. After 3 months, subjects continued on blinded treatments for an additional 3 months during which time subjects originally randomized to placebo began treatment with blinded Enbrel at 25 mg twice weekly (designated as placebo/Enbrel in Table 13); subjects originally randomized to Enbrel continued on the originally randomized dose (designated as Enbrel/Enbrel groups in Table 13).

Study II evaluated 611 subjects who received placebo or Enbrel SC at doses of 25 mg or 50 mg twice a week for 3 months. After 3 months of randomized, blinded treatment, subjects in all three arms began receiving open-label Enbrel at 25 mg twice weekly for 9 additional months.

Response to treatment in both studies was assessed after 3 months of therapy and was defined as the proportion of subjects who achieved a reduction in PASI score of at least 75% from baseline. The PASI is a composite score that takes into consideration both the fraction of body surface area affected and the nature and severity of psoriatic changes within the affected regions (induration, erythema and scaling).

Other evaluated outcomes included the proportion of subjects who achieved a score of “clear” or “minimal” by the Static Physician Global Assessment (sPGA) and the proportion of subjects with a reduction of PASI of at least 50% from baseline. The sPGA is a 6-category scale ranging from “5 = severe” to “0 = none” indicating the physician’s overall assessment of the PsO severity focusing on induration, erythema and scaling. Treatment success of “clear” or “minimal” consisted of none or minimal elevation in plaque, up to faint red coloration in erythema and none or minimal fine scale over $< 5\%$ of the plaque.

Subjects in all treatment groups and in both studies had a median baseline PASI score ranging from 15 to 17, and the percentage of subjects with baseline sPGA classifications ranged from 54% to 66% for moderate, 17% to 26% for marked and 1% to 5% for severe. Across all treatment groups, the percentage of subjects who previously received systemic therapy for PsO ranged from 61% to 65% in Study I and 71% to 75% in Study II, and those who previously received phototherapy ranged from 44% to 50% in Study I and 72% to 73% in Study II.

More subjects randomized to Enbrel than placebo achieved at least a 75% reduction from baseline PASI score (PASI 75) with a dose response relationship across doses of 25 mg once a week, 25 mg twice a week and 50 mg twice a week (Tables 13 and 14). The individual components of the PASI (induration, erythema and scaling) contributed comparably to the overall treatment-associated improvement in PASI.

Table 13. Study I Outcomes at 3 and 6 Months

| | Placebo/Enbrel 25 mg BIW (N = 168) | Enbrel/Enbrel | | |
|----------------------------------|--|-----------------------|------------------------|------------------------|
| | | 25 mg QW (N = 169) | 25 mg BIW (N = 167) | 50 mg BIW (N = 168) |
| 3 Months | | | | |
| PASI 75 n (%) | 6 (4%) | 23 (14%) ^a | 53 (32%) ^b | 79 (47%) ^b |
| Difference (95% CI) | | 10% (4, 16) | 28% (21, 36) | 43% (35, 52) |
| sPGA, “clear” or “minimal” n (%) | 8 (5%) | 36 (21%) ^b | 53 (32%) ^b | 79 (47%) ^b |
| Difference (95% CI) | | 17% (10, 24) | 27% (19, 35) | 42% (34, 50) |
| PASI 50 n (%) | 24 (14%) | 62 (37%) ^b | 90 (54%) ^b | 119 (71%) ^b |
| Difference (95% CI) | | 22% (13, 31) | 40% (30, 49) | 57% (48, 65) |
| 6 Months | | | | |
| PASI 75 n (%) | 55 (33%) | 36 (21%) | 68 (41%) | 90 (54%) |

^a p = 0.001 compared with placebo.

^b p < 0.0001 compared with placebo.

Table 14. Study II Outcomes at 3 Months

| | Placebo (N = 204) | Enbrel | |
|----------------------------------|----------------------|------------------------|------------------------|
| | | 25 mg BIW (N = 204) | 50 mg BIW (N = 203) |
| PASI 75 n (%) | 6 (3%) | 66 (32%) ^a | 94 (46%) ^a |
| Difference (95% CI) | | 29% (23, 36) | 43% (36, 51) |
| sPGA, “clear” or “minimal” n (%) | 7 (3%) | 75 (37%) ^a | 109 (54%) ^a |
| Difference (95% CI) | | 34% (26, 41) | 50% (43, 58) |
| PASI 50 n (%) | 18 (9%) | 124 (61%) ^a | 147 (72%) ^a |
| Difference (95% CI) | | 52% (44, 60) | 64% (56, 71) |

^a p < 0.0001 compared with placebo.

Among PASI 75 achievers in both studies, the median time to PASI 50 and PASI 75 was approximately 1 month and approximately 2 months, respectively, after the start of therapy with either 25 or 50 mg twice a week.

In Study I, subjects who achieved PASI 75 at month 6 were entered into a study drug withdrawal and retreatment period. Following withdrawal of study drug, these subjects had a median duration of PASI 75 of between 1 and 2 months.

In Study I, among subjects who were PASI 75 responders at 3 months, retreatment with their original blinded Enbrel dose after discontinuation of up to 5 months resulted in a similar proportion of responders as in the initial double-blind portion of the study.

In Study II, most subjects initially randomized to 50 mg twice a week continued in the study after month 3 and had their Enbrel dose decreased to 25 mg twice a week. Of the 91 subjects who were PASI 75 responders at month 3, 70 (77%) maintained their PASI 75 response at month 6.

14.6 Pediatric Plaque Psoriasis

A 48-week, randomized, double-blind, placebo-controlled study enrolled 211 pediatric subjects 4 to 17 years of age, with moderate to severe plaque psoriasis (PsO) (as defined by a sPGA score ≥ 3 [moderate, marked, or severe], involving $\geq 10\%$ of the body surface area, and a PASI score ≥ 12) who were candidates for phototherapy or systemic therapy, or were inadequately controlled on topical therapy. Subjects in all treatment groups had a median baseline PASI score of 16.4, and the percentage of subjects with baseline sPGA classifications was 65% for moderate, 31% for marked, and 3% for severe. Across all treatment groups, the percentage of subjects who previously received systemic or phototherapy for PsO was 57%.

Subjects received Enbrel 0.8 mg/kg (up to a maximum of 50 mg per dose) or placebo once weekly for the first 12 weeks. After 12 weeks, subjects entered a 24-week open-label treatment period, in which all subjects received Enbrel at the same dose. This was followed by a 12-week withdrawal-retreatment period.

Response to treatment was assessed after 12 weeks of therapy and was defined as the proportion of subjects who achieved a reduction in PASI score of at least 75% from baseline. The PASI is a composite score that takes into consideration both the fraction of body surface area affected and the nature and severity of psoriatic changes within the affected regions (induration, erythema and scaling).

Other evaluated outcomes included the proportion of subjects who achieved a score of “clear” or “almost clear” by the sPGA and the proportion of subjects with a reduction in PASI score of at least 90% from baseline. The sPGA is a 6-category scale ranging from “5 = severe” to “0 = none” indicating the physician’s overall assessment of the PsO severity focusing on induration, erythema and scaling. Treatment success of “clear” or “almost clear” consisted of none or minimal elevation in plaque, up to faint red coloration in erythema and none or minimal fine scale over $< 5\%$ of the plaque.

Efficacy results are summarized in Table 15.

Table 15. Pediatric Plaque Psoriasis Outcomes at 12 Weeks

| | Placebo (N = 105) | Enbrel 0.8 mg/kg Once Weekly (N = 106) |
|--------------------------------------|----------------------|--|
| PASI 75, n (%) | 12 (11%) | 60 (57%) |
| PASI 90, n (%) | 7 (7%) | 29 (27%) |
| sPGA “clear” or “almost clear” n (%) | 14 (13%) | 55 (52%) |

Maintenance of Response

To evaluate maintenance of response, subjects who achieved PASI 75 response at Week 36 were re-randomized to either Enbrel or placebo during a 12-week randomized withdrawal period. The maintenance of PASI 75 response was evaluated at Week 48. The proportion of subjects who maintained PASI 75 response at Week 48 was higher for subjects treated with Enbrel (65%) compared to those treated with placebo (49%).

15 REFERENCES

1. National Cancer Institute. Surveillance, Epidemiology, and End Results Database (SEER) Program. SEER Incidence Crude Rates, 13 Registries, 1992-2002.
2. Bröms G, Granath F, Ekbohm A, et al. Low Risk of Birth Defects for Infants Whose Mothers Are Treated With Anti-Tumor Necrosis Factor Agents During Pregnancy. *Clin Gastroenterol Hepatol*. 2016;14:234-241.e5

16 HOW SUPPLIED/STORAGE AND HANDLING

Enbrel (etanercept) injection is supplied as a clear and colorless sterile, preservative-free solution for subcutaneous administration in single-dose prefilled syringes, an Enbrel single-dose prefilled SureClick autoinjector with a 27-gauge, ½-inch needle, or a single-dose vial. The needle cover of the prefilled syringe and the needle cover within the white cap of the SureClick autoinjector contains dry natural rubber (a derivative of latex).

Each Enbrel® Mini single-dose prefilled cartridge for use with the AutoTouch® reusable autoinjector contains 1.0 mL of 50 mg/mL of etanercept. The needle cover within the purple cap of the Enbrel Mini single-dose prefilled cartridge contains dry natural rubber (a derivative of latex).

The AutoTouch reusable autoinjector contains no drug and must use an Enbrel Mini single-dose prefilled cartridge. In addition, the AutoTouch Connect™ reusable autoinjector would allow for data connectivity via Bluetooth wireless technology.

| | | |
|---|--|--------------------------------------|
| 50 mg/mL single-dose prefilled syringe | Carton of 4 | NDC 58406-435-04 NDC 58406-021-04 |
| 50 mg/mL single-dose prefilled SureClick autoinjector | Carton of 4 | NDC 58406-445-04 NDC 58406-032-04 |
| 25 mg/0.5 mL single-dose prefilled syringe | Carton of 4 | NDC 58406-455-04 NDC 58406-010-04 |
| 50 mg/mL Enbrel Mini single-dose prefilled cartridge for use with the AutoTouch reusable autoinjector only | Cartridges: Carton of 4 | NDC 58406-456-04 NDC 58406-044-04 |
| | AutoTouch Reusable Autoinjector: Carton of 1 | NDC 58406-470-01 |
| | AutoTouch Connect Reusable Autoinjector: Carton of 1 | NDC 58406-480-01 |
| 25 mg/0.5 mL single-dose vial | Carton of 4 | NDC 58406-055-04 |

Enbrel should be refrigerated at 36°F to 46°F (2°C to 8°C) in the original carton to protect from light or physical damage. Do not store Enbrel in extreme heat or cold. DO NOT SHAKE. DO NOT FREEZE.

For convenience, storage of individual single-dose prefilled syringes, SureClick autoinjectors, single-dose vials, or Enbrel Mini cartridges at room temperature at 68°F to 77°F (20°C to 25°C) for a maximum single period of 30 days is permissible, with protection from light and sources of heat. Once a single-dose prefilled syringe, SureClick autoinjector, single-dose vial, or Enbrel Mini cartridge has been stored at room temperature, it should not be placed back into the refrigerator. If not used within 30 days at room temperature, the single-dose prefilled syringe, SureClick autoinjector, single-dose vial, or Enbrel Mini cartridge should be discarded.

Do not use Enbrel beyond the expiration date stamped on the carton or barrel/cartridge label. Keep out of the reach of children.

The AutoTouch reusable autoinjector should be stored at room temperature. Do not refrigerate the AutoTouch reusable autoinjector.

Enbrel Lyophilized Powder (Used for Weight-based Dosing)

Enbrel (etanercept) for Injection is supplied as lyophilized powder for reconstitution in a multiple-dose vial. Each vial is supplied in a carton containing four dose trays. Each dose tray contains one 25 mg vial of etanercept lyophilized powder, one diluent syringe (1 mL Sterile Bacteriostatic Water for Injection, USP, containing 0.9%

benzyl alcohol), one 27-gauge ½-inch needle, one vial adapter, and one plunger. Each carton contains four “Mixing Date:” stickers.

| | | |
|--------------------------|-------------|------------------|
| 25 mg multiple-dose vial | Carton of 4 | NDC 58406-425-34 |
|--------------------------|-------------|------------------|

Enbrel should be refrigerated at 36°F to 46°F (2°C to 8°C) in the original carton to protect from light or physical damage. Do not store Enbrel in extreme heat or cold. DO NOT SHAKE. DO NOT FREEZE.

For convenience, storage of an individual dose tray containing Enbrel multiple-dose vial and diluent syringe at room temperature at 68°F to 77°F (20°C to 25°C) for a maximum single period of 14 days is permissible, with protection from light, sources of heat, and humidity. Once the dose tray has been stored at room temperature, it should not be placed back into the refrigerator. If not used within 14 days at room temperature, the dose tray should be discarded. Once a vial has been reconstituted, the solution must be used immediately or may be refrigerated for up to 14 days.

Do not use Enbrel beyond the expiration date stamped on the dose tray. Keep out of the reach of children.

17 PATIENT COUNSELING INFORMATION

Advise the patient and/or caregiver to read the FDA-approved patient labeling (*Medication Guide and Instructions for Use*) before the patient starts using Enbrel, and each time the prescription is renewed, as there may be new information they need to know.

Patients or their caregivers should be provided the Enbrel “Medication Guide” and provided an opportunity to read it and ask questions prior to initiation of therapy. The healthcare provider should ask the patient questions to determine any risk factors for treatment. Patients developing signs and symptoms of infection should seek medical evaluation immediately.

Patient Counseling

Patients should be advised of the potential benefits and risks of Enbrel. Physicians should instruct their patients to read the Medication Guide before starting Enbrel therapy and to reread each time the prescription is renewed.

Infections

Inform patients that Enbrel may lower the ability of their immune system to fight infections. Advise patients of the importance of contacting their doctor if they develop any symptoms of infection, tuberculosis or reactivation of hepatitis B virus infections.

Other Medical Conditions

Advise patients to report any signs of new or worsening medical conditions, such as central nervous system demyelinating disorders, heart failure or autoimmune disorders, such as lupus-like syndrome or autoimmune hepatitis. Counsel about the risk of lymphoma and other malignancies while receiving Enbrel. Advise patients to report any symptoms suggestive of a pancytopenia, such as bruising, bleeding, persistent fever or pallor.

Allergic Reactions

Advise patients to seek immediate medical attention if they experience any symptoms of severe allergic reactions. Advise latex-sensitive patients that the following components contain dry natural rubber (a derivative of latex) that may cause allergic reactions in individuals sensitive to latex: the needle cover of the prefilled syringe, the needle cover within the white cap of the SureClick autoinjector, and within the purple cap of the Enbrel Mini cartridge.

Administration of Enbrel

If a patient or caregiver is to administer Enbrel, the patient or caregiver should be instructed in injection techniques and how to measure and administer the correct dose [see the Enbrel (etanercept) “Instructions for Use” insert]. For weight-based dosing, instruct caregivers and patients on the proper techniques for preparing, storing, measuring, and administering Enbrel solution in a single-dose vial or reconstituted lyophilized powder in a multiple-dose vial.

The first injection should be performed under the supervision of a qualified healthcare professional. The patient's or caregiver's ability to inject subcutaneously should be assessed. Patients and caregivers should be instructed in the technique, as well as proper syringe and needle disposal, and be cautioned against reuse of needles and syringes.

When using the SureClick autoinjector to administer Enbrel, the patient or caregiver should be informed that the window turns yellow when the injection is complete. After removing the autoinjector, if the window has not turned yellow, or if it looks like the medicine is still injecting, this means the patient has not received a full dose. The patient or caregiver should be advised to call their healthcare provider immediately.

When using the AutoTouch reusable autoinjector to administer Enbrel, the patient or caregiver should be informed that the status button turns green upon contact with the skin, flashes green after starting the injection, and turns off at completion of the injection. After removing the AutoTouch reusable autoinjector from the skin, if the status button has turned red, the patient or caregiver should be advised to call 1-888-4Enbrel (1-888-436-2735) immediately. If it looks like the medicine is still injecting or there is still fluid in Enbrel Mini, this means the patient has not received a full dose. The patient or caregiver should be advised to call their healthcare provider immediately.

A puncture-resistant container for disposal of needles, syringes, SureClick autoinjectors, single-dose vials, and Enbrel Mini cartridges should be used. If the product is intended for multiple use, additional syringes, needles and alcohol swabs will be required.

Patients can be advised to call 1-888-4ENBREL (1-888-436-2735) or visit www.enbrel.com for more information about Enbrel.



Enbrel® (etanercept)

Manufactured by:

Immunex Corporation

Thousand Oaks, CA 91320-1799

U.S. License Number 1132

Patent: <http://pat.amgen.com/enbrel/>

© 1998-2022 Immunex Corporation. All rights reserved.

1XXXXXX – v68



This printed material is recyclable.

Medication Guide

**Enbrel® (en-brel)
(etanercept)**

injection, for subcutaneous use

**Enbrel® (en-brel)
(etanercept)**

for injection, for subcutaneous use

Read the Medication Guide that comes with Enbrel before you start using it and each time you get a refill. There may be new information. This Medication Guide does not take the place of talking with your healthcare provider about your medical condition or treatment. It is important to remain under your healthcare provider's care while using Enbrel. Enbrel is a prescription medicine called a Tumor Necrosis Factor (TNF) blocker that affects your immune system.

What is the most important information I should know about Enbrel?

Enbrel may cause serious side effects, including:

1. Risk of Infection
2. Risk of Cancer

1. Risk of infection

Enbrel can lower the ability of your immune system to fight infections. Some people have serious infections while taking Enbrel. These infections include tuberculosis (TB), and infections caused by viruses, fungi, or bacteria that spread throughout their body. Some people have died from these infections.

- Your healthcare provider should test you for TB before starting Enbrel.
- Your healthcare provider should monitor you closely for symptoms of TB during treatment with Enbrel even if you tested negative for TB.
- Your healthcare provider should check you for symptoms of any type of infection before, during, and after your treatment with Enbrel.

You should not start taking Enbrel if you have any kind of infection unless your healthcare provider says it is okay.

2. Risk of cancer

- There have been cases of unusual cancers, some resulting in death, in children and teenage patients who started using TNF-blocking agents at less than 18 years of age.
- For children, teenagers, and adults taking TNF-blocker medicines, including Enbrel, the chances of getting lymphoma or other cancers may increase.
- People with rheumatoid arthritis, especially those with very active disease, may be more likely to get lymphoma.

Before starting Enbrel, be sure to talk to your healthcare provider:

Enbrel may not be right for you. Before starting Enbrel, tell your healthcare provider about all of your medical conditions, including:

Infections. Tell your healthcare provider if you:

- have an infection. See **“What is the most important information I should know about Enbrel?”**
- are being treated for an infection.
- think you have an infection.
- have symptoms of an infection such as fever, sweats or chills, cough or flu-like symptoms, shortness of breath, blood in your phlegm, weight loss, muscle aches, warm, red or painful areas on your skin, sores on your body, diarrhea or stomach pain, burning when you urinate or urinating more often than normal, and feel very tired.
- have any open cuts on your body.
- get a lot of infections or have infections that keep coming back.
- have diabetes, HIV, or a weak immune system. People with these conditions have a higher chance for infections.
- have TB, or have been in close contact with someone with TB.
- were born in, lived in, or traveled to countries where there is a risk for getting TB. Ask your healthcare provider if you are not sure.
- live, have lived in, or traveled to certain parts of the country (such as the Ohio and Mississippi River valleys, or the Southwest) where there is a greater risk for getting certain kinds of fungal infections (histoplasmosis, coccidioidomycosis, blastomycosis). These infections may happen or become more severe if you use Enbrel. Ask your healthcare provider if you do not know if you live or have lived in an area where these infections are common.
- have or have had hepatitis B.

Also, before starting Enbrel, tell your healthcare provider:

- **About all the medicines you take including prescription and over-the-counter medicines, vitamins and herbal supplements including:**
 - **Orencia (abatacept) or Kineret (anakinra).** You have a higher chance for serious infections when taking Enbrel with Orencia or Kineret.
 - **Cyclophosphamide (Cytoxan).** You may have a higher chance for getting certain cancers when taking Enbrel with cyclophosphamide.
 - **Anti-diabetic medicines.** If you have diabetes and are taking medication to control your diabetes, your healthcare provider may decide you need less anti-diabetic medicine while taking Enbrel.

Keep a list of all your medications with you to show your healthcare provider and pharmacist each time you get a new medicine. Ask your healthcare provider if you are not sure if your medicine is one listed above.

Other important medical information you should tell your healthcare provider before starting Enbrel, includes if you:

- have or had a nervous system problem such as multiple sclerosis or Guillain-Barré syndrome.
- have or had heart failure.
- are scheduled to have surgery.
- have recently received or are scheduled to receive a vaccine.
 - All vaccines should be brought up-to-date before starting Enbrel.
 - People taking Enbrel should not receive live vaccines.
 - Ask your healthcare provider if you are not sure if you received a live vaccine.
- are allergic to rubber or latex.
 - The needle covers on the single-dose prefilled syringes, the needle covers within the white caps on the single-dose prefilled SureClick autoinjectors, and within the purple caps of the Enbrel Mini cartridges contain dry natural rubber.
- have been around someone with varicella zoster (chicken pox).
- are pregnant or plan to become pregnant. It is not known if Enbrel will harm your unborn baby. If you took Enbrel during pregnancy, talk to your healthcare provider prior to administration of live vaccines to your infant.
- are breastfeeding or plan to breastfeed. Enbrel can pass into breast milk. Talk to your healthcare provider about the best way to feed your baby while taking Enbrel.

See the section “**What are the possible side effects of Enbrel?**” below for more information.

What is Enbrel?

Enbrel is a prescription medicine called a Tumor Necrosis Factor (TNF) blocker.

Enbrel is used to treat:

- **moderately to severely active rheumatoid arthritis (RA).** Enbrel can be used alone or with a medicine called methotrexate.
- **moderately to severely active polyarticular juvenile idiopathic arthritis (JIA) in children ages 2 years and older.**
- **psoriatic arthritis (PsA).** Enbrel can be used alone or with methotrexate.
- **ankylosing spondylitis (AS).**
- **chronic moderate to severe plaque psoriasis (PsO) in children 4 years and older and adults** who may benefit from taking injections or pills (systemic therapy) or phototherapy (ultraviolet light).

You may continue to use other medicines that help treat your condition while taking Enbrel, such as nonsteroidal anti-inflammatory drugs (NSAIDs) and prescription steroids, as recommended by your healthcare provider.

Enbrel can help reduce joint damage and the signs and symptoms of the above-mentioned diseases. People with these diseases have too much of a protein called tumor necrosis factor (TNF), which is made by your immune system. Enbrel can reduce the effect of TNF in the body and block the damage that too much TNF can cause, but it can also lower the ability of your immune system to fight infections. See “**What is the most important information I should know about Enbrel?**” and “**What are the possible side effects of Enbrel?**”

Who should not use Enbrel?

Do not use Enbrel if you:

- have an infection that has spread through your body (sepsis).

How should I use Enbrel?

- Enbrel is given as an injection under the skin (subcutaneous or SC).
- If your healthcare provider decides that you or a caregiver can give the injections of Enbrel at home, you or your caregiver should receive training on the right way to prepare and inject Enbrel. Do not try to inject Enbrel until you have been shown the right way by your healthcare provider or nurse.
- Enbrel is available in the forms listed below. Your healthcare provider will prescribe the type that is best for you.
 - Single-dose Prefilled Syringe
 - Single-dose Prefilled SureClick Autoinjector
 - Single-dose Vial
 - Multiple-dose Vial
 - Enbrel Mini single-dose cartridge for use with the AutoTouch reusable autoinjector
- See the detailed “Instructions for Use” with this Medication Guide for instructions about the right way to store, prepare, and give your Enbrel injections at home.

- Your healthcare provider will tell you how often you should use Enbrel. Do not miss any doses of Enbrel. If you forget to use Enbrel, inject your dose as soon as you remember. Then, take your next dose at your regular(ly) scheduled time. In case you are not sure when to inject Enbrel, call your healthcare provider or pharmacist. **Do not use Enbrel more often than as directed by your healthcare provider.**
- Your child's dose of Enbrel depends on his or her weight. Your child's healthcare provider will tell you which form of Enbrel to use and how much to give your child.

What are the possible side effects of Enbrel?

Enbrel can cause serious side effects, including:

- **See "What is the most important information I should know about Enbrel?"**
- **Infections.** Enbrel can make you more likely to get infections or make any infection that you have worse. Call your healthcare provider right away if you have any symptoms of an infection. See **"Before starting Enbrel, be sure to talk to your healthcare provider"** for a list of symptoms of infection.
- **Previous Hepatitis B infection.** If you have been previously infected with the hepatitis B virus (a virus that affects the liver), the virus can become active while you use Enbrel. Your healthcare provider may do a blood test before you start treatment with Enbrel and while you use Enbrel.
- **Nervous system problems.** Rarely, people who use TNF-blocker medicines have developed nervous system problems such as multiple sclerosis, seizures, or inflammation of the nerves of the eyes. Tell your healthcare provider right away if you get any of these symptoms: numbness or tingling in any part of your body, vision changes, weakness in your arms and legs, and dizziness.
- **Blood problems.** Low blood counts have been seen with other TNF-blocker medicines. Your body may not make enough of the blood cells that help fight infections or help stop bleeding. Symptoms include fever, bruising or bleeding very easily, or looking pale.
- **Heart failure including new heart failure or worsening of heart failure you already have.** New or worse heart failure can happen in people who use TNF-blocker medicines like Enbrel. If you have heart failure your condition should be watched closely while you take Enbrel. Call your healthcare provider right away if you get new or worsening symptoms of heart failure while taking Enbrel, such as shortness of breath or swelling of your lower legs or feet.
- **Psoriasis.** Some people using Enbrel developed new psoriasis or worsening of psoriasis they already had. Tell your healthcare provider if you develop red scaly patches or raised bumps that may be filled with pus. Your healthcare provider may decide to stop your treatment with Enbrel.
- **Allergic reactions.** Allergic reactions can happen to people who use TNF-blocker medicines. Call your healthcare provider right away if you have any symptoms of an allergic reaction. Symptoms of an allergic reaction include a severe rash, a swollen face, or trouble breathing.
- **Autoimmune reactions, including:**
 - **Lupus-like syndrome.** Symptoms include a rash on your face and arms that gets worse in the sun. Tell your healthcare provider if you have this symptom. Symptoms may go away when you stop using Enbrel.
 - **Autoimmune hepatitis.** Liver problems can happen in people who use TNF-blocker medicines, including Enbrel. These problems can lead to liver failure and death. Call your healthcare provider right away if you have any of these symptoms: feel very tired, skin or eyes look yellow, poor appetite or vomiting, pain on the right side of your stomach (abdomen).

Common side effects of Enbrel include:

- **Injection site reactions** such as redness, itching, pain, swelling, bleeding or bruising. These symptoms usually go away within 3 to 5 days. If you have pain, redness, or swelling around the injection site that does not go away or gets worse, call your healthcare provider.
- **Upper respiratory infections** (sinus infections).

These are not all the side effects with Enbrel. Tell your healthcare provider about any side effect that bothers you or does not go away.

Call your doctor for medical advice about side effects. You may report side effects to FDA at 1-800-FDA-1088.

How should I store Enbrel?

- Store Enbrel in the refrigerator between 36°F to 46°F (2°C to 8°C).
- Store Enbrel in the original carton to protect from light or damage.
- If needed, you may store your dose tray for the multiple-dose vial at room temperature between 68°F to 77°F (20°C to 25°C) for up to 14 days.
 - When the dose tray has reached room temperature, do not put it back in the refrigerator.
 - Throw away the dose tray that has been stored at room temperature after 14 days.
- Mixed Enbrel multiple-dose vials should be used right away or kept in the refrigerator between 36°F to 46°F (2°C to 8°C) for up to 14 days.

- If needed, you may store the Enbrel prefilled syringe, SureClick autoinjector, single-dose vial, or Enbrel Mini cartridge at room temperature between 68°F to 77°F (20°C to 25°C) for up to 30 days.
 - When Enbrel has reached room temperature, do not put it back in the refrigerator.
 - Throw away Enbrel that has been stored at room temperature after 30 days.
- **Do not** store Enbrel in extreme heat or cold such as in your vehicle's glove box or trunk.
- **Do not shake.**
- **Do not freeze.**
- **Keep Enbrel and all medicines out of the reach of children.**

General information about the safe and effective use of Enbrel.

Medicines are sometimes prescribed for purposes not mentioned in a Medication Guide. Do not use Enbrel for a condition for which it was not prescribed. Do not give Enbrel to other people, even if they have the same condition. It may harm them.

This Medication Guide summarizes the most important information about Enbrel. If you would like more information, talk with your healthcare provider. You can ask your healthcare provider or pharmacist for information about Enbrel that was written for healthcare professionals.

What are the ingredients in Enbrel?

Single-dose Prefilled Syringe, Single-dose Prefilled SureClick Autoinjector, Single-dose Vial and Enbrel Mini single-dose cartridge:

Active Ingredient: etanercept

Inactive Ingredients: L-arginine hydrochloride, sodium chloride, and sucrose

Multiple-dose Vial:

Active Ingredient: etanercept

Inactive Ingredients: mannitol, sucrose, tromethamine



Manufactured by: Immunex Corporation, Thousand Oaks, CA 91320-1799, U.S. License Number 1132

Immunex Corporation. All rights reserved. 1XXXXXX – v20

For more information, call 1 888 4ENBREL (1 888 436 2735) or www.enbrel.com.



This printed material is recyclable

This Medication Guide has been approved by the U.S. Food and Drug Administration.

Revised: 06/2022

Instructions for Use
Enbrel® (en-brel)
(etanercept)
injection, for subcutaneous use
Single-Dose Prefilled SureClick® Autoinjector
50 mg/mL

This Instructions for Use contains information on how to inject ENBREL.

Guide to parts

| Before use | After use |
|---|---|
| <p>Purple start button</p> <p>Expiration date</p> <p>Window</p> <p>Medicine</p> <p>White cap on</p> | <p>Expiration date</p> <p>Yellow window (injection complete)</p> <p>Green safety guard (needle inside)</p> <p>White cap off</p> |
| <p>Important: Needle is inside the green safety guard.</p> | |

Important

Important Information You Need to Know Before Injecting ENBREL:

- It is important that you **do not** try to give yourself or someone else the injection unless you have received training from your healthcare provider.
- The white cap on the Enbrel SureClick autoinjector contains a needle cover (located inside the cap) that contains dry natural rubber, which is made from latex. Tell your healthcare provider if you are allergic to latex.

Storing your Enbrel SureClick autoinjector:

- Keep the autoinjector and all medicines out of the reach of children.
- Keep the autoinjector in the original carton to protect from light.
- Keep the autoinjector in the refrigerator at 36°F to 46°F (2°C to 8°C).
- After removing from the refrigerator, the autoinjector may be kept at room temperature between 68°F to 77°F (20°C to 25°C) and must be used within 30 days. **Do not** put it back in the refrigerator after it has reached room temperature.
- Throw away Enbrel that has been stored at room temperature for more than 30 days.
- **Do not** store the autoinjector in extreme heat or cold. For example, avoid storing the autoinjector in your vehicle's glove box or trunk.
- **Do not** freeze or use the autoinjector if it has been frozen.

Using your Enbrel SureClick autoinjector:

- **Do not** use the autoinjector after the expiration date on the label.
- **Do not** shake the autoinjector.
- **Do not** remove the white cap from the autoinjector until you are ready to inject. Leaving the cap off for more than 5 minutes can dry out the medicine.
- **Do not** use the autoinjector if it has been dropped on a hard surface. Part of the autoinjector may be broken even if you cannot see the break. Use a new autoinjector and call 1-888-4ENBREL (1-888-436-2735).
- **Children must weigh at least 138 pounds to use the Enbrel SureClick autoinjector. Children who weigh less than 138 pounds should use a different form of Enbrel.**

For more information or help, contact your healthcare provider, visit www.enbrel.com or call 1-888-4ENBREL (1-888-436-2735).

Step 1: Preparing to inject ENBREL

1A Remove the autoinjector from the carton.

Carefully lift the autoinjector straight up out of the carton.

Before you inject, always check the label of the autoinjector to make sure you have the correct medicine and the correct dose of ENBREL.

Put the original carton with any unused autoinjectors back in the refrigerator.

Wait at least **30 minutes** for the autoinjector to reach room temperature before injecting.

This is important for administering the entire dose and helps minimize discomfort. ENBREL may take longer to inject if it has not reached room temperature. **Do not** heat the autoinjector. Let it come to room temperature naturally.

- **Do not** put the autoinjector back in the refrigerator after it has reached room temperature.
- **Do not** try to warm the autoinjector by using a heat source such as hot water or microwave.
- **Do not** leave the autoinjector in direct sunlight.
- **Do not** shake the autoinjector.
- **Do not** remove the white cap from the autoinjector yet.

30 minutes

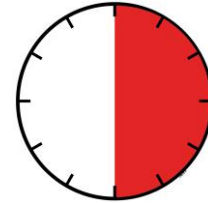

1B Inspect the Enbrel SureClick autoinjector.

Green safety guard (needle inside)

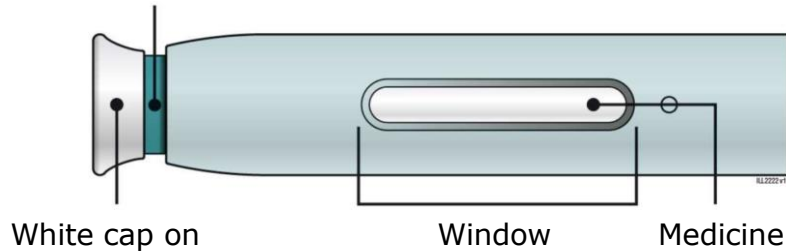

Make sure the medicine in the window is clear and colorless.

It is okay if you see small white particles in the medicine.

- **Do not** use the autoinjector if the medicine is cloudy or discolored or contains large lumps, flakes, or colored particles.
- **Do not** use the autoinjector if any part appears cracked or broken.
- **Do not** use the autoinjector if the autoinjector has been dropped.
- **Do not** use the autoinjector if the white cap is missing or not securely attached.
- **Do not** use the autoinjector if the expiration date printed on the label has passed.

In all cases, use a new autoinjector and call 1-888-4ENBREL (1-888-436-2735).

1C Gather all materials needed for your injection.

Wash your hands thoroughly with soap and water.

On a clean, well-lit work surface, place the:

- New autoinjector
- Alcohol wipes
- Cotton balls or gauze pads
- Adhesive bandages
- Sharps disposal container (**see Step 4: Finish**)



1D Prepare and clean your injection site.

Only use these injection sites:

- Thigh
- Stomach (abdomen), except for a **2** inch area around your navel (belly button)
- Outer area of upper arm (only if someone else is giving you the injection)

Clean your injection site with an alcohol wipe. Let your skin dry.

- **Do not** touch this area again before injecting.
- Choose a different site each time you give yourself an injection. If you want to use the same injection site, make sure it is not the same spot you used for the last injection.
- **Do not** inject into areas where the skin is tender, bruised, red, or hard. Avoid injecting into areas with scars or stretch marks.
- Avoid injecting directly into raised, thick, red, or scaly skin patch or lesion.

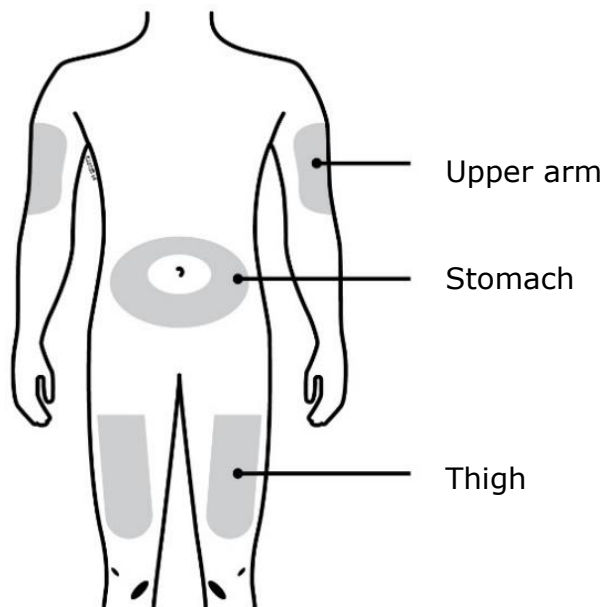

Step 2: Get ready

2A Pull the white cap straight off only when you are ready to inject.

Do not leave the white cap off for more than **5 minutes**. This can dry out the medicine.

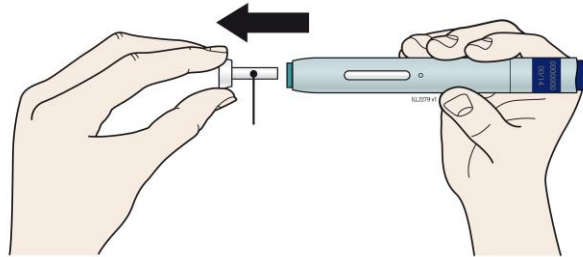

White cap

5 minutes

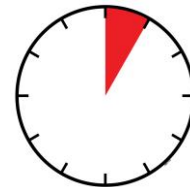

It is normal to see a drop of liquid at the end of the needle or green safety guard.

- **Do not** twist, bend, or wiggle the white cap.
- **Do not** put the white cap back onto the autoinjector.
- **Do not** put fingers into the green safety guard.
- **Do not** remove the white cap from the autoinjector until you are ready to inject.

If you are unable to inject, please contact your healthcare provider.

2B Create a firm surface at the selected injection site (thigh, stomach, or outer areas of the upper arm), by using **either** the Stretch method **or** the Pinch method.

Stretch method:

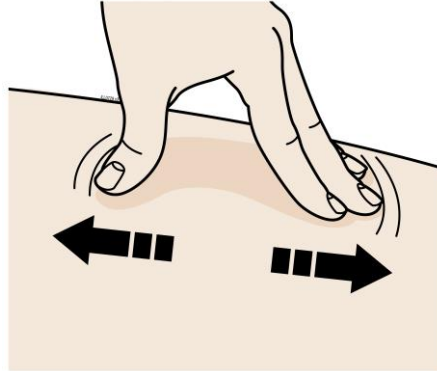

Stretch the skin firmly by moving your thumb and fingers in opposite directions, creating an area about **2** inches wide.

OR

Pinch method:

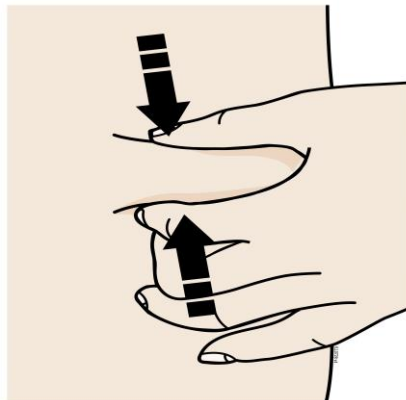

Pinch the skin firmly between your thumb and fingers, creating an area about **2** inches wide.

Important: Keep skin stretched or pinched while injecting.

Step 3: Inject

3A Keep holding the stretched or pinched skin. With the white cap off, **put** the green safety guard on your skin at 90 degrees. **The needle is inside** the green safety guard. Do not touch the purple start button yet.

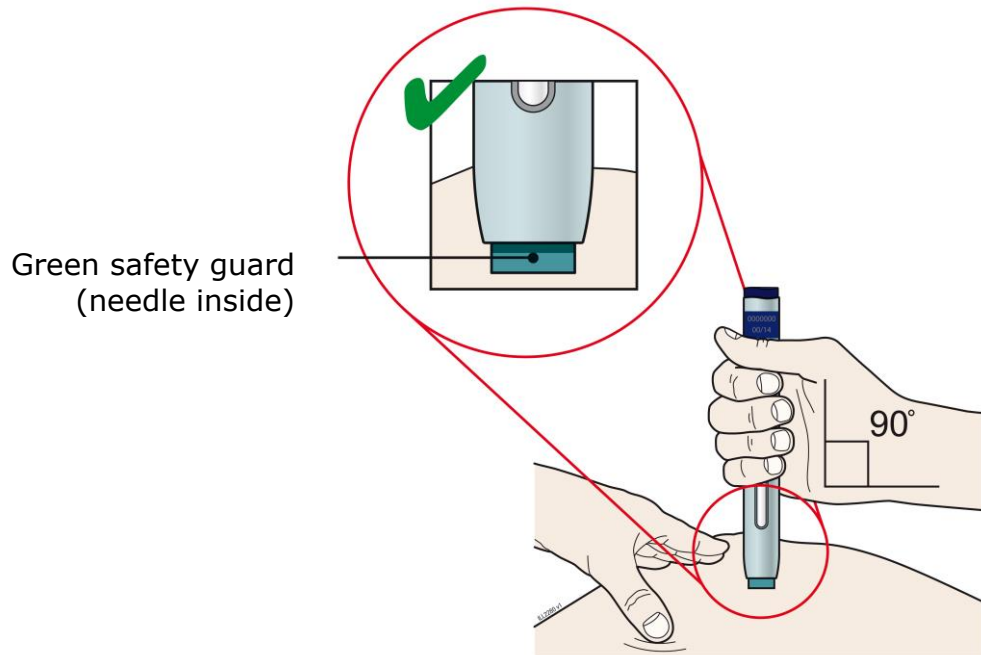

3B Firmly **push** down the autoinjector onto the skin until it stops moving.

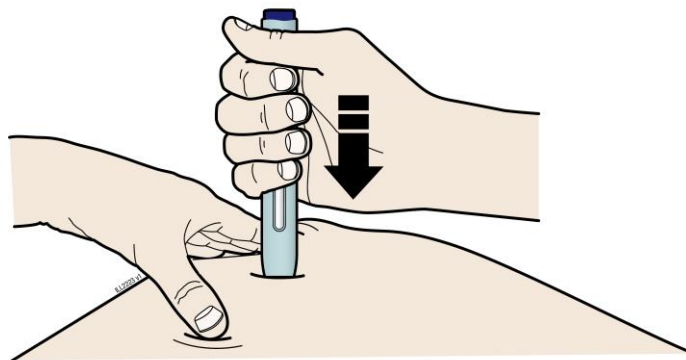

Important: You must push all the way down but **do not** touch the purple start button until you are ready to inject.

3C When you are ready to inject, **press** the purple start button. You will hear a click.

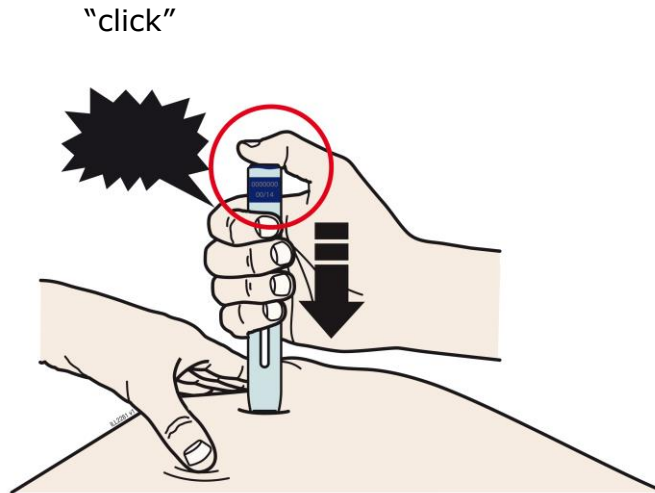

3D Keep **pushing** the autoinjector down on your skin. Then lift your thumb while still holding the autoinjector on your skin. Your injection could take about 15 seconds to complete.

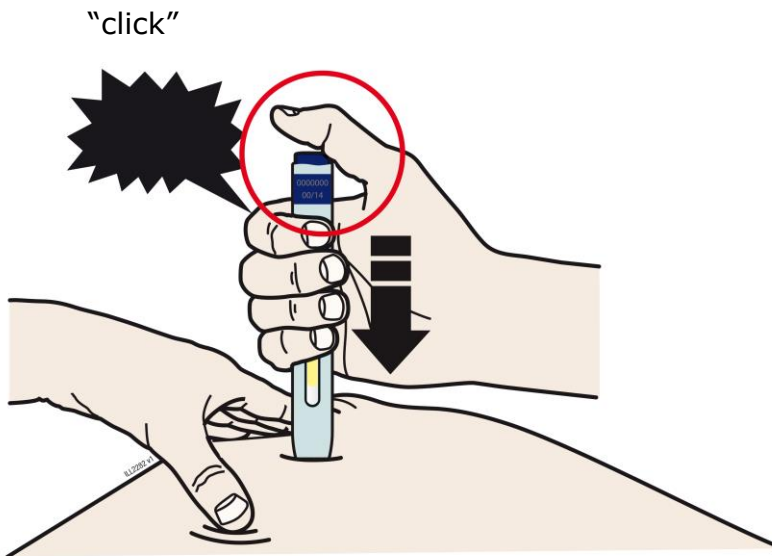

15 seconds

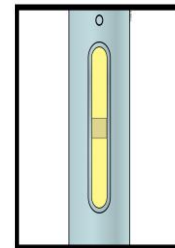
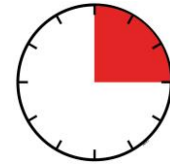

Window turns from clear to yellow when the injection is done. You may hear a second click.

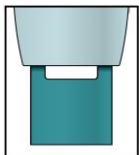

NOTE: After you remove the autoinjector from your skin, the needle will be automatically covered.

Important: When you remove the autoinjector, if the window has not turned yellow, or if it looks like the medicine is still injecting, this means you have not received a full dose. Call your healthcare provider immediately.

Step 4: Finish

4A Throw away the used autoinjector and white needle cap.

Put the used autoinjector and white needle cap in an FDA-cleared sharps disposal container right away after use. **Do not** throw away (dispose of) the autoinjector or white cap in your household trash.

If you do not have an FDA-cleared sharps disposal container, you may use a household container that is:

- made of a heavy-duty plastic,
- can be closed with a tight-fitting, puncture-resistant lid, without sharps being able to come out,
- upright and stable during use,
- leak-resistant, and
- properly labeled to warn of hazardous waste inside the container.

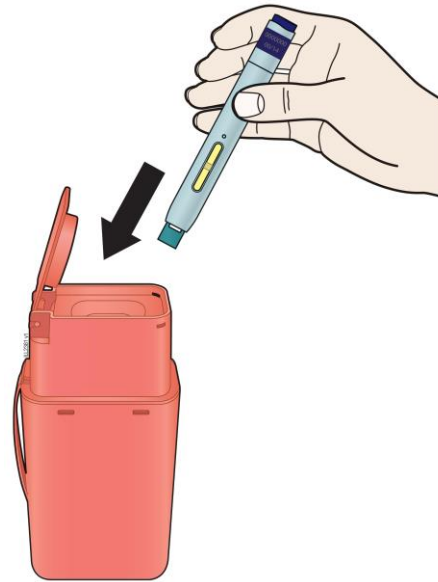

When your sharps disposal container is almost full, you will need to follow your community guidelines for the right way to dispose of your sharps disposal container. There may be state or local laws about how you should throw away used needles and syringes. For more information about safe sharps disposal, and for specific information about sharps disposal in the state that you live in, go to the FDA's website at: <http://www.fda.gov/safesharpsdisposal>

Do not dispose of your used sharps disposal container in your household trash unless your community guidelines permit this. Do not recycle your used sharps disposal container.

- **Do not** reuse the autoinjector.
- **Do not** recap the autoinjector or put fingers into the green safety guard.

Important: Always keep the sharps disposal container out of the reach of children.

4B Check the injection site.

If there is blood, press a cotton ball or gauze pad on your injection site.
Apply an adhesive bandage if needed.

Do not rub the injection site.

Commonly Asked Questions

What will happen if I press the purple start button before I am ready to do the injection on my skin?

Even when you press the purple start button, the injection will only happen when the green safety guard is also pushed into the autoinjector.

Can I move the autoinjector around on my skin while I am choosing an injection site?

It is okay to move the autoinjector around on the injection site as long as you **do not** press the purple start button. However, if you press the purple start button and the green safety guard is pushed into the autoinjector, the injection will begin.

Can I release the purple start button after I start my injection?

You can release the purple start button, but continue to hold the autoinjector firmly against your skin during the injection.

Will the purple start button pop up after I release my thumb?

The purple start button may not pop up after you release your thumb if you held your thumb down during the injection. This is okay.

What do I do if I did not hear a second click?

If you did not hear a second click, you can confirm a complete injection by checking that the window has turned yellow.

Whom do I contact if I need help with the autoinjector or my injection?

A healthcare provider familiar with ENBREL should be able to answer your questions. For more information, call 1-888-4ENBREL (1-888-436-2735) or visit www.enbrel.com.

This Instructions for Use has been approved by the U.S. Food and Drug Administration.



Manufactured by:

Immunex Corporation

Thousand Oaks, CA 91320-1799

U.S. License Number 1132

©1998 – 2016, 2019-2022 Immunex Corporation. All rights reserved.

<part number> Revised: 8/2022 v17



This printed material is recyclable.

**Instructions for Use
Enbrel® (en-brel)
(etanercept)
injection, for subcutaneous use
Single-dose Prefilled Syringe**

How do I prepare and give an injection with Enbrel Single-dose Prefilled Syringe?

There are 2 types of Enbrel single-dose prefilled syringes:

- The 50 mg/mL single-dose prefilled syringe that contains one 50 mg dose of Enbrel.
- The 25 mg/0.5 mL single-dose prefilled syringe that contains one 25 mg dose of Enbrel.

Your healthcare provider will tell you which one to use.

A 50 mg dose can be given as one injection using a 50 mg/mL single-dose prefilled syringe or as two injections using 25 mg/0.5 mL single-dose prefilled syringes. Your healthcare provider will tell you whether the two injections with 25 mg/0.5 mL single-dose prefilled syringes should be given on the same day once a week or on two different days (3 or 4 days apart) in the same week.

Children must weigh at least 138 pounds to use the Enbrel 50 mg/mL single-dose prefilled syringe. Children who weigh less than 138 pounds should use a different form of Enbrel. The Enbrel 25 mg/0.5 mL single-dose prefilled syringe should not be used in pediatric patients weighing less than 68 pounds.

Important: The needle cover on the single-dose prefilled syringe is composed of dry natural rubber, which is made from latex. Tell your healthcare provider if you are allergic to latex.

Storage of your Enbrel prefilled syringe

- Store the Enbrel prefilled syringe in the refrigerator at 36°F to 46°F (2°C to 8°C).
- Store the Enbrel prefilled syringe in the original carton to protect from light or physical damage.
- If needed, you may store your Enbrel prefilled syringe at room temperature between 68°F to 77°F (20°C to 25°C) for up to 30 days.
 - Once the Enbrel prefilled syringe has reached room temperature, do not put it back in the refrigerator.
- Throw away any Enbrel prefilled syringe that has been stored at room temperature after 30 days.
- **Do not** store the Enbrel prefilled syringe in extreme heat or cold. For example, avoid storing Enbrel prefilled syringe in your vehicle's glove box or trunk.
- **Do not freeze.**
- **Do not shake.**
- **Keep the Enbrel prefilled syringe and all medicines out of the reach of children.**

If you have any questions about storage, contact your healthcare provider or call 1-888-4ENBREL (1-888-436-2735) for further instructions.

Step 1: Setting Up for an Injection

1. Select a clean, well-lit, flat work surface, such as a table.
2. Take the Enbrel carton containing the prefilled syringes out of the refrigerator and place it on your flat work surface. Remove one prefilled syringe and place it on your work surface. Carefully lift the prefilled syringe straight up out of the box. **Do not shake** the prefilled syringe of Enbrel. Place the carton containing any remaining prefilled syringes back into the refrigerator at 36°F to 46°F (2°C to 8°C).
3. Check the expiration date on the prefilled syringe. If the expiration date has passed, **do not** use the prefilled syringe and contact your pharmacist or call 1-888-4ENBREL (1-888-436-2735) for assistance.
4. **Do not** use the prefilled syringe if the needle cover is missing or not securely attached. Call 1-888-4ENBREL (1-888-436-2735).
5. For a more comfortable injection, leave the prefilled syringe at room temperature for about 15 to 30 minutes before injecting. **Do not** remove the needle cover while allowing it to reach room temperature. **Do not** warm Enbrel in any other way (for example, **do not** warm it in a microwave or in hot water).
6. Hold the prefilled syringe with the covered needle pointing down. If bubbles are seen in the syringe, very gently tap the prefilled syringe to allow any bubbles to rise to the top of the syringe. Turn the syringe so that the purple horizontal lines on the barrel are directly facing you. Check to see if the amount of liquid in the syringe falls between the purple lines. The top of the liquid may be curved. If the syringe does not have the right amount of liquid, **do not** use that syringe. Contact your pharmacist or call 1-888-4ENBREL (1-888-436-2735) for assistance.

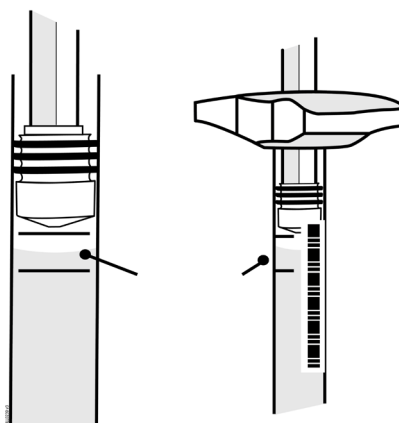

Fill Level Indicator

7. Assemble the additional supplies you will need for your injection. These include an alcohol swab, a cotton ball or gauze, and a sharps disposal container (see “**Step 4: Disposing of Supplies**”).
8. Wash your hands with soap and warm water.
9. Make sure the solution in the prefilled syringe is clear and colorless. You may notice small white particles in the solution. These particles are formed from Enbrel and this is acceptable. However, **do not inject the solution if it is cloudy or discolored, or contains large or colored particles**, call 1-888-4ENBREL (1-888-436-2735).

Step 2: Choosing and Preparing an Injection Site

1. Recommended injection sites for Enbrel using a prefilled syringe include:
 - the front of the middle thigh
 - the stomach area (abdomen), except for the 2-inch area right around the navel (belly button)
 - the outer area of the upper arm (only if someone else is giving you the injection)

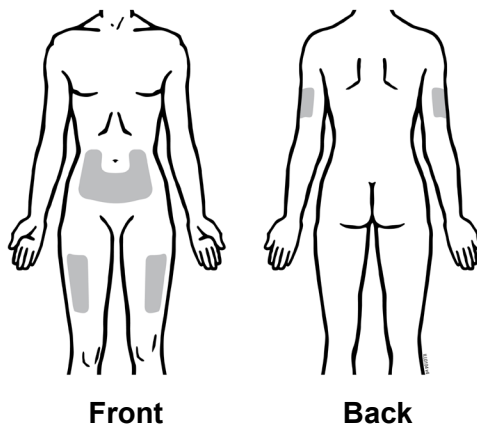

2. Rotate the site for each injection. **Do not** inject into areas where the skin is tender, bruised, red, or hard. Avoid areas with scars or stretch marks.
3. If you have psoriasis, you should not inject directly into any raised, thick, red, or scaly skin patches or lesions.
4. To prepare the area of skin where Enbrel is to be injected, wipe the injection site with an alcohol swab. **Do not touch this area again before giving the injection.**

Step 3: Injecting Enbrel Using a Prefilled Syringe

Do not remove the needle cover from the prefilled syringe until you are ready to inject.

1. Pick up the prefilled syringe from your flat work surface. Hold the barrel of the prefilled syringe with one hand and pull the needle cover straight off, only when you are ready to inject. **Do not** leave the needle cover off for more than **5 minutes**. This can dry out the medicine.

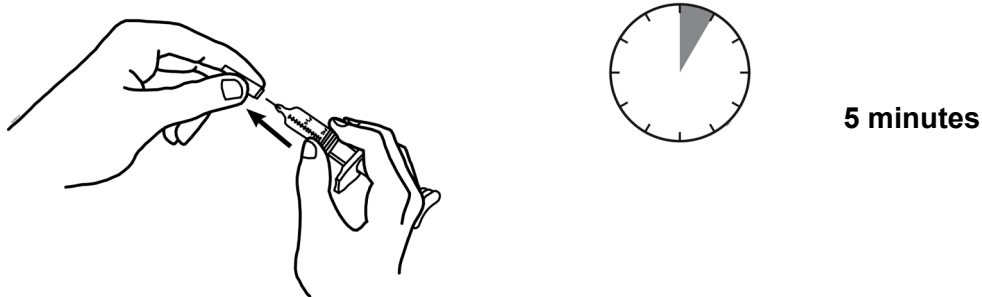

To avoid damaging the needle, **do not** twist or bend the needle cover while you are removing it, and **do not** try to put the needle cover back onto the prefilled syringe.

When you remove the needle cover, there may be a drop of liquid at the end of the needle; this is normal. **Do not** touch the needle or allow it to touch any surface. **Do not** touch or bump the plunger. Doing so could cause the liquid to leak out.

2. Holding the syringe with the needle pointing up, check the syringe for air bubbles. If there are bubbles, **gently** tap the syringe with your finger until the air bubbles rise to the top of the syringe. Slowly push the plunger up to force the air bubbles out of the syringe.
3. Holding the syringe in one hand like a pencil, use the other hand to gently pinch a fold of skin at the cleaned injection site and hold it firmly.
4. With a quick and “dart-like” motion, insert the needle at a 45-degree angle into the skin.

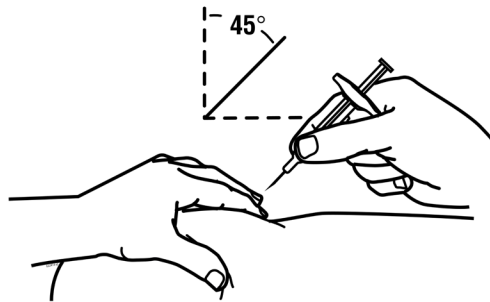

5. When the needle is completely inserted into the skin, let go of the skin that you are holding. With your free hand, hold the syringe near its base to stabilize it. Then push the plunger to inject all of the Enbrel solution at a slow, steady rate.

6. When the syringe is empty, pull the needle out of the skin, being careful to keep it at the same angle as inserted. There may be a little bleeding at the injection site. You can press a cotton ball or gauze over the injection site for 10 seconds. **Do not** rub the injection site. If needed, you may cover the injection site with a bandage.

Step 4: Disposing of Supplies

The syringe should **never** be reused. **Never** recap a needle.

- Put the used prefilled syringes in a FDA-cleared sharps disposal container right away after use. **Do not** throw away (dispose of) prefilled syringes in your household trash.
- If you do not have a FDA-cleared sharps disposal container, you may use a household container that is:
 - made of a heavy-duty plastic,
 - can be closed with a tight-fitting, puncture-resistant lid, without sharps being able to come out,
 - upright and stable during use,
 - leak-resistant, and
 - properly labeled to warn of hazardous waste inside the container.
- When your sharps disposal container is almost full, you will need to follow your community guidelines for the right way to dispose of your sharps disposal container. There may be state or local laws about how you should throw away used syringes and needles. For more information about safe sharps disposal, and for specific information about sharps disposal in the state that you live in, go to the FDA's website at: <http://www.fda.gov/safesharpsdisposal>
- **Do not** reuse the syringe.
- **Do not** recycle the syringe or sharps disposal container or throw them into household trash.

Important: Always keep the sharps disposal container out of the reach of children.

A healthcare provider familiar with Enbrel should answer all questions. Call 1-888-4ENBREL (1-888-436-2735) or visit www.enbrel.com for more information about Enbrel.

This Instructions for Use have been approved by the U.S. Food and Drug Administration.

AMGEN[®]

Manufactured by:

Immunex Corporation

Thousand Oaks, CA 91320-1799

U.S. License Number 1132

© 1998 – 2016, 2019-2020, 2022 Immunex Corporation. All rights reserved.

1XXXXXX – v11

Revised: 06/2022



This printed material is recyclable.

**Instructions for Use
Enbrel® (en-brel)
(etanercept)
injection, for subcutaneous use
single-dose vial**

Read this Instructions for Use before you start taking Enbrel and each time you get a refill. There may be new information. This information does not take the place of talking to your healthcare provider about your medical condition and treatment.

Step 1: Set up



1a. Strength and dose

The strength of the Enbrel single-dose vial is different than the Enbrel multiple-dose vial.

Each single-dose vial contains 25 mg (0.5 mL).

Review your prescription carefully for dose and dosing schedule. Only inject Enbrel after you or your caregiver has received training by your healthcare provider. Your healthcare provider will tell you how often you should use Enbrel. **Do not use Enbrel more often than directed by your healthcare provider.** If you forget to use Enbrel, inject your dose right away. Inject your next dose at your regular scheduled time. If you do not know when to inject Enbrel, call your healthcare provider or pharmacist.

Keep Enbrel out of the reach of children.

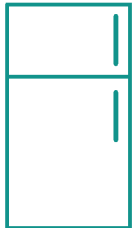

1b. Store Enbrel single-dose vials

Store Enbrel in the refrigerator between 36°F to 46°F (2°C to 8°C). You may also store the Enbrel single-dose vials at room temperature between 68°F to 77°F (20°C to 25°C) for up to 30 days. Throw away Enbrel that has been stored at room temperature after 30 days.

Do not shake.

Do not freeze or store in extreme heat or cold.

Store Enbrel in the original carton to protect from light or damage.

If your dose is
0.5 mL, or LESS

Remove 1 single-dose vial



If your dose is MORE
than 0.5 mL

Remove 2 single-dose vials



1c. Remove correct number of vials

Remove the correct number of Enbrel single-dose vials from the original carton.

Check your prescription to determine if your dose will require 1 or 2 single-dose vials.

Your dose is determined in milliliters (mL).

Your child's dose of Enbrel depends on his or her weight. Your child's healthcare provider will tell you which form of Enbrel to use and how much to give your child.

Green vial cap

WAIT

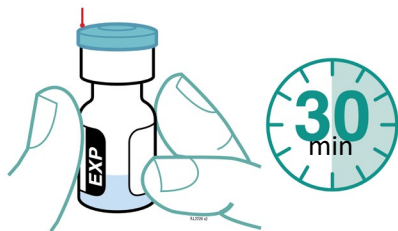

1d. Inspect the single-dose vial(s)

Leave the single-dose vial(s) at room temperature, with the green cap(s) on, for at least 30 minutes.

Enbrel is clear and colorless. There may be small white particles in the solution. Check the expiration date.

Keep out of direct sunlight.

Do not use Enbrel if:

- the expiration date has passed
- the green cap is not attached
- it has lumps, is discolored, or is cloudy.

If there are any issues with your Enbrel single-dose vials, please call 1-888-4ENBREL (1-888-436-2735).

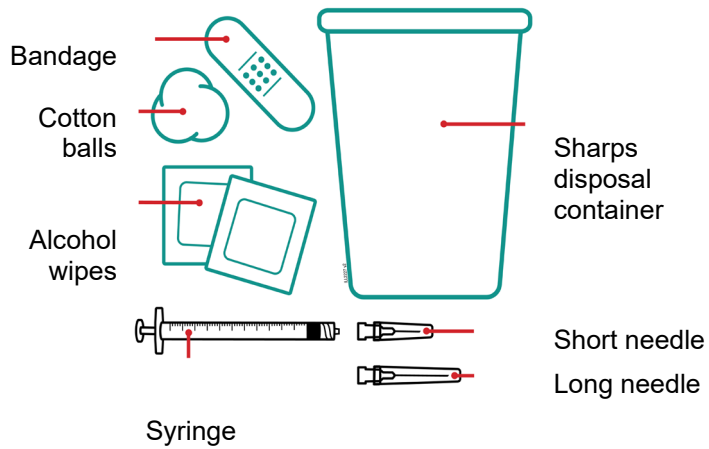

1e. Gather all materials and wash hands
Wash your hands with soap and water.

Place the following items on a clean well-lit, flat surface:

- 1 mL syringe
- Long needle: for withdrawal
- Short needle: for injection
- Alcohol wipes
- Cotton balls
- Bandage
- Sharps disposal container

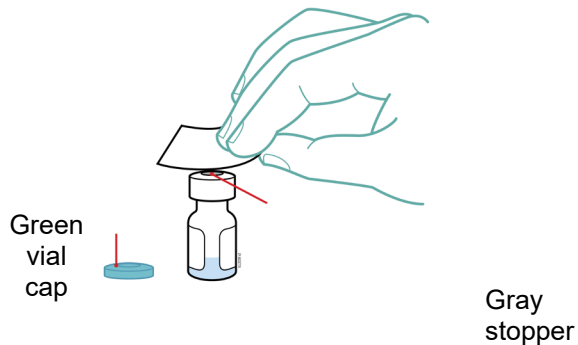

1f. Pop off the green vial cap then wipe the gray stopper
Use an alcohol wipe to clean the gray stopper.

If you require a second single-dose vial, clean the gray stopper of the second single-dose vial with a new alcohol wipe.

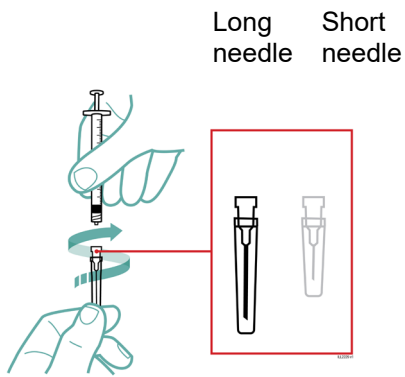

1g. Attach the long needle to the syringe
Twist the long needle onto the syringe.

Step 2: Prepare dose

Plunger

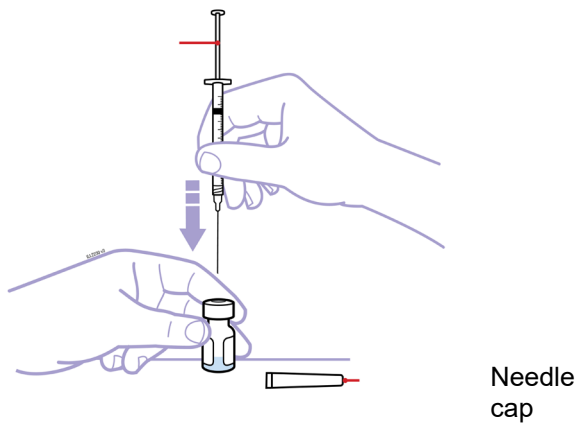

2a. Pull plunger back, insert needle, and push air into single-dose vial
Pull the needle cap straight off and away from your body. Save the needle cap for later.

Pull the syringe plunger back to 0.5 mL.

Hold the single-dose vial on a flat surface with 1 hand. Insert the long needle through the gray rubber stopper above the medicine in the single-dose vial.

Slowly push 0.5 mL of air into the single-dose vial.

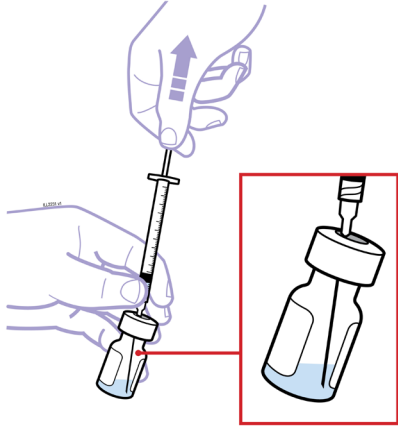

2b. Tilt the single-dose vial to withdraw **all** medicine
Slowly pull back the plunger to fill the syringe **with all the medicine from the single-dose vial**.

Remove needle from the single-dose vial.

The air in the syringe will be removed later.

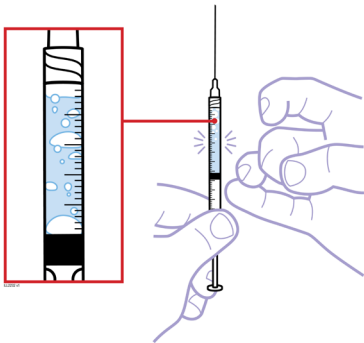

2c. Gently tap the syringe with fingers to release bubbles
Gently tap the syringe with your fingers to release air pockets and bubbles until they rise to the top of the syringe.

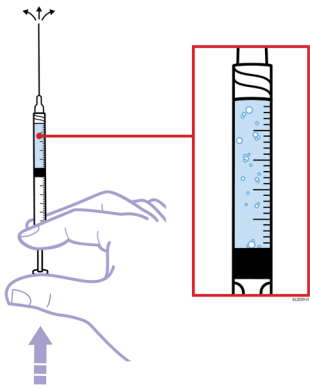

2d. Push out large air pockets and bubbles
After you have gently tapped the large air pockets and bubbles to the top of the syringe, push the plunger up to remove the air out of the syringe.

Small amounts of tiny air bubbles are ok.

If you need 1 single-dose vial, push the plunger to your **total prescribed dose** and continue to step 2g.

If you need more than 1 single-dose vial to get your **total prescribed dose**, follow these 2 steps:

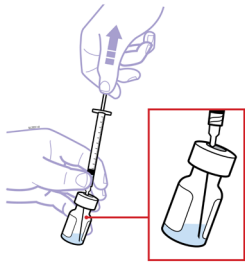

2e. Insert the same needle in the second vial
Tilt vial to withdraw medicine. Slowly pull back the plunger to fill the syringe **with all medicine from the vial**.

Remove the needle from the single-dose vial.

The air will be removed in the next step

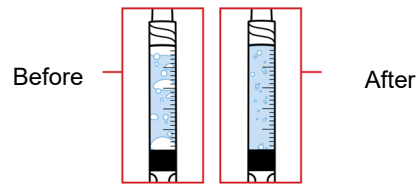

2f. Gently tap the syringe to remove the air
Hold the needle pointing up and gently tap the syringe so air bubbles rise to the top.

Push the plunger to **your prescribed dose**.

Small amounts of tiny air bubbles are ok.

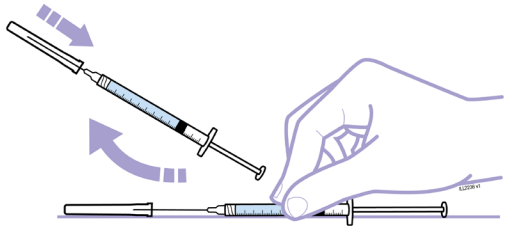

2g. Use 1-handed scoop method to recap
For your safety, place the needle cap on a flat surface.

Using 1 hand, slide the needle into the cap and scoop upwards to cap the needle, without using your other hand.

Then use your other hand to secure the cap and snap into place.

Step 3: Inject and throw away

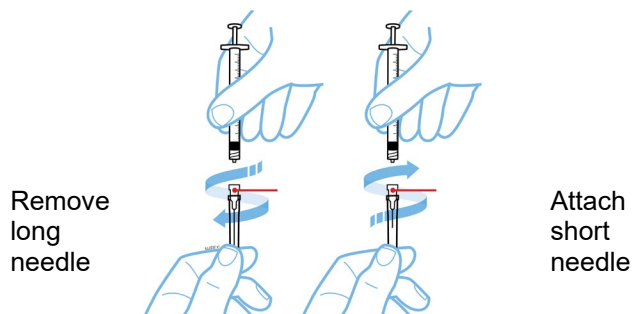

3a. Replace the long needle with the short needle

Twist the long needle off of the syringe.

Throw away the long needle in the sharps disposal container.

Twist the short needle onto the syringe.

Do not remove the needle cover until you are ready to inject.

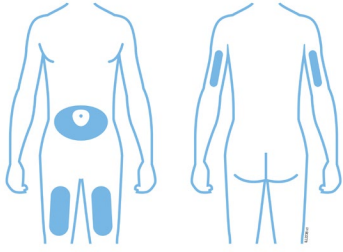

3b. Choose and clean the injection site

- thigh or stomach (avoid 2 inches around the navel)
- back of upper arm (only if someone else is giving the injection)

Choose a different site each time you give yourself an injection. Avoid injecting into tender, raised, red or scaly skin.

Clean the injection site with an alcohol wipe and let dry. **Do not** touch this area again before injecting.

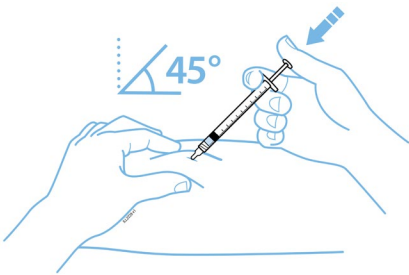

3c. Pinch and inject Enbrel

Gently pinch skin. With a quick firm action, insert the needle into your skin at a 45-degree angle.

When the needle is completely inserted into the skin, slowly push the plunger all the way down.

When the syringe is empty, remove the needle and syringe from your skin. Do not recap the needle.

Do not rub the injection site. If you see drops of blood at the injection site, you can press a cotton ball over the injection site until bleeding has stopped. Apply an adhesive bandage, if needed.

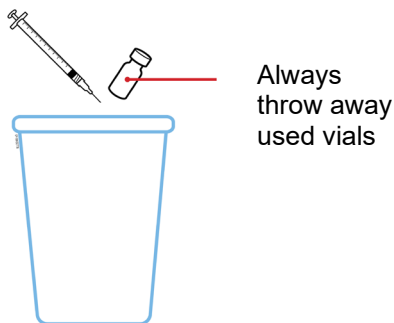

3d. Throw away the used single-dose vials, needles and syringe

Single-dose vials do not contain preservatives and are for **1-time use only**. Unused medicine in the single-dose vials must be thrown away in a sharps disposal container.

Additional disposal information

Do not throw away the vials, needles, and syringe in your household trash.

If you do not have a FDA-cleared sharps disposal container, you may use a household container that is:

- made of a heavy-duty plastic
- can be closed with a tight-fitting, puncture-resistant lid without sharps being able to come out
- upright and stable during use
- leak-resistant
- properly labeled to warn of hazardous waste inside the container

When your sharps disposal container is almost full, you will need to follow your community guidelines for the right way to throw away your sharps disposal container. There may be state or local laws about how you should throw away used vials, needles and syringes.

For more information about safe sharps disposal, and for specific information about sharps disposal in the state that you live in, go to the FDA's website at: <http://www.fda.gov/safesharpsdisposal>

- Do not throw away your used sharps disposal container in your household trash unless your community guidelines permit this. Do not recycle your used sharps disposal container.
- Do not reuse the vials, syringe, or needles.
- Do not recycle the vials, syringe, needles, or sharps disposal container or throw them into household trash.

Important: Always keep the sharps disposal container out of the reach of children.

If you experience any difficulty using your Enbrel single-dose vials, please call 1-888-4ENBREL (1-888-436-2735).

If you have any questions about your Enbrel dosing, please call your healthcare provider.

This Instructions for Use has been approved by the U.S. Food and Drug Administration.

AMGEN[®]

Manufactured by:

Immunex Corporation

Thousand Oaks, CA 91320-1799

U.S. License Number 1132

© 1998-2020, 2022 Immunex Corporation. All rights reserved.

[part number]

Revised: 06/2022 v2

 This printed material is recyclable.

Front Panel

**Read these instructions before
using Enbrel[®]
Single-Dose Vial
Instructions for Use**

**Instructions for Use
Enbrel® (en-brel)
(etanercept)
for injection, for subcutaneous use
Multiple-dose Vial**

How do I prepare and give an injection with Enbrel multiple-dose vial?

A multiple-dose vial contains 25 mg of Enbrel.

Storage of Enbrel multiple-dose vial

- Store Enbrel multiple-dose vial in the refrigerator at 36°F to 46°F (2°C to 8°C).
- Store Enbrel multiple-dose vial in the original carton to protect from light or physical damage.
- If needed, you may store your Enbrel multiple-dose vial and diluent syringe (dose tray) at room temperature between 68°F to 77°F (20°C to 25°C) for up to 14 days.
 - Once Enbrel multiple-dose vial has reached room temperature, do not put it back in the refrigerator.
- Throw away Enbrel multiple-dose vial that has been stored at room temperature after 14 days.
- Mixed (reconstituted) Enbrel multiple-dose vial should be used right away or kept in the refrigerator at 36°F to 46°F (2°C to 8°C) for up to 14 days.
- **Do not** store Enbrel multiple-dose vial in extreme heat or cold. For example, avoid storing Enbrel multiple-dose vial in your vehicle's glove box or trunk.
- **Do not freeze.**
- **Do not shake.**
- **Keep Enbrel multiple-dose vial and all medicines out of the reach of children.**

If you have any questions about storage, contact your healthcare provider or call 1-888-4ENBREL (1-888-436-2735) for further instructions.

Step 1: Setting Up for an Injection

1. Select a clean, well-lit, flat work surface, such as a table.
2. Take the Enbrel dose tray out of the refrigerator and place it on your flat work surface.

3. Check the expiration date on the dose tray. If the expiration date has passed, **do not** use the dose tray. Also check to make sure the dose tray has 5 items as pictured below:

- One prefilled diluent syringe containing 1 mL of diluent (liquid) with attached adapter and twist-off cap
- One plunger
- One Enbrel vial
- One 27-gauge ½ inch needle in hard plastic cover
- One vial adapter

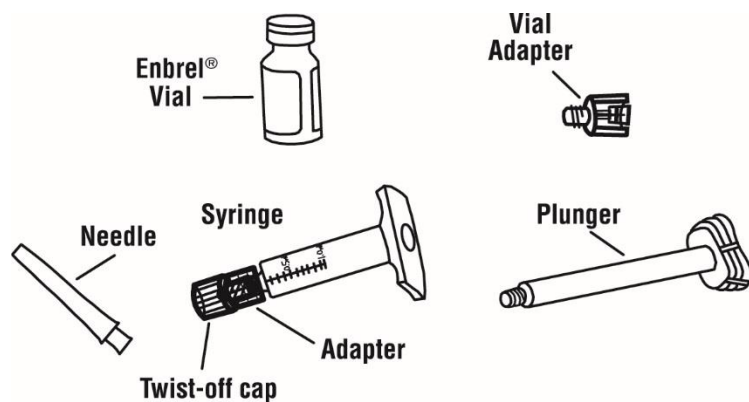

If the expiration date has passed, the five items are not included in the dose tray or if any item looks damaged, contact your pharmacist or call 1-888-4ENBREL (1-888-436-2735) for assistance.

4. For a more comfortable injection, leave the dose tray at room temperature for about 15 to 30 minutes before injecting.
5. Wash your hands with soap and warm water.
6. Peel the paper seal off the dose tray and remove all items.
7. Inspect the volume of diluent in the syringe with the twist-off cap pointing down. Use the unit markings on the side of the syringe to make sure there is at least 1 mL of liquid in the syringe. If the level of liquid is below the 1 mL mark, **do not** use. Contact your pharmacist or call 1-888-4ENBREL (1-888-436-2735) for assistance.
8. **Do not** use the syringe if the twist-off cap is missing or not securely attached. Call 1-888-4ENBREL (1-888-436-2735).
9. Two alcohol swabs should be available for the preparation and injection of Enbrel. Alcohol swabs can be found at your local drug store.

Step 2: Preparing the Enbrel Solution

There are two methods for preparing the Enbrel solution. For some children, one vial of Enbrel solution can be used for more than one dose. The free-hand method should be used for children on Enbrel who are using one vial of Enbrel solution for more than one dose. **You should not use the vial adapter method if you will be using the vial more than once.** Ask your healthcare provider if you have questions about which method to use.

- **The Vial Adapter Method**

Adults and larger children on Enbrel may use the vial adapter device to assist with mixing the powder with the liquid and withdrawing Enbrel, and then use a 27-gauge needle to inject the dose. **This method should not be used for children using multiple doses from the same vial of Enbrel.** The instructions for using the vial adapter method are in Step 2A.

- **The Free-Hand Method**

In the free-hand method, a 25-gauge needle is used to assist with mixing the powder with the liquid and withdrawing Enbrel, and a 27-gauge needle is used to inject the dose. Obtain 25-gauge needles from your healthcare provider. Instructions for using the free-hand method are in Step 2B.

The instructions for preparing additional doses from the same vial of Enbrel solution are in Step 3. For each additional dose, you will need two new needles (one 25-gauge needle to withdraw the solution and one 27-gauge needle for injection) and one new empty syringe (1 mL). **Never reuse a syringe or needle.**

If you are using the vial of Enbrel for more than one dose, you should write the date you mixed the powder and liquid in the area marked "Mixing Date:" on the sticker supplied with these instructions, and attach the sticker to the Enbrel vial.

After you have withdrawn the dose of Enbrel that you need, store the Enbrel vial (in the dose tray) in the refrigerator at 36° to 46°F (2° to 8°C) as soon as possible, but always within 4 hours of mixing the solution. **Do not freeze.** If you have any questions about storage, contact your healthcare provider or call 1-888-4ENBREL (1-888-436-2735) for further instructions.

The Enbrel solution must be used within 14 days of the mixing date. You should discard the Enbrel vial and any remaining solution if it is not used within 14 days. **Do not** mix any remaining liquid in one vial of Enbrel solution with another.

STEP 2A: Vial Adapter Method

1. Remove the pink plastic cap from the Enbrel vial. **Do not** remove the gray stopper or silver metal ring around the top of the Enbrel vial.

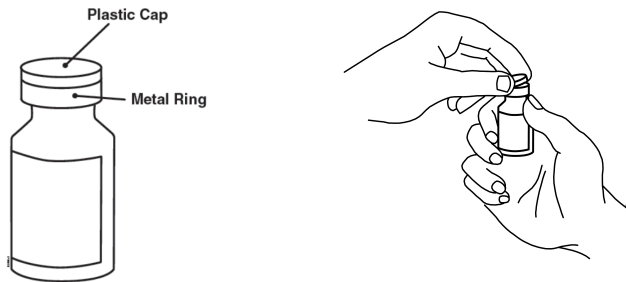

2. Place the Enbrel vial on your flat work surface or turn your dose tray upside down and place your Enbrel vial in the round space marked "V". Use one alcohol swab to clean the gray stopper on the Enbrel vial. **Do not** touch the gray stopper with your hands.
3. Open the wrapper that contains the 27-gauge needle by peeling apart the tabs and set the needle aside for later use.

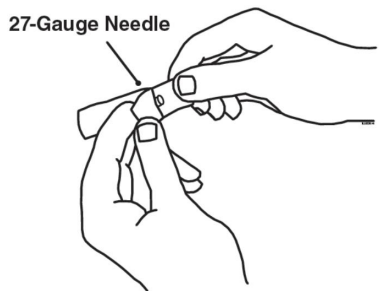

4. Open the wrapper that contains the vial adapter by peeling apart the tabs and set the vial adapter aside for later use. **Do not** touch the vial adapter's twist-on end or the spike inside.

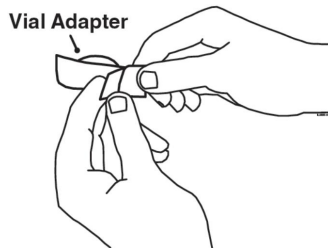

- Slide the plunger into the flange end of the syringe.

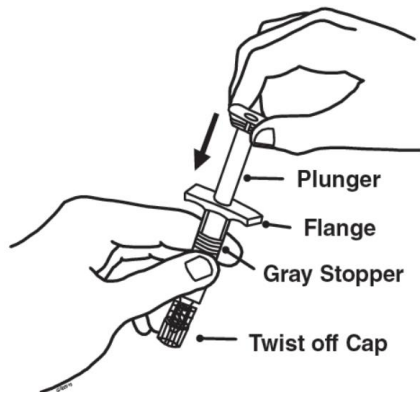

- Attach the plunger to the gray rubber stopper in the syringe by turning the plunger clockwise until you feel a slight resistance.

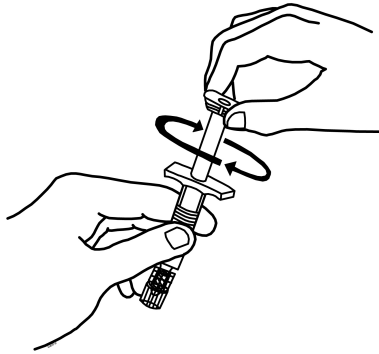

- Remove the twist-off cap from the prefilled diluent syringe by turning counter-clockwise. **Do not** bump or touch the plunger. Doing so could cause the liquid to leak out. You may see a drop of liquid when removing the cap. This is normal. Place the cap on your flat work surface. **Do not** touch the syringe tip.



- Once the twist-off cap is removed, pick up the vial adapter with your free-hand. Twist the vial adapter onto the syringe, turning clockwise until you feel a slight resistance. **Do not over-tighten.**

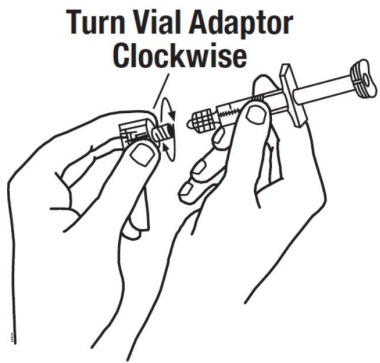

9. Hold the Enbrel vial upright on your flat work surface. Grasp the sides of the vial adaptor and place it over the top of the Enbrel vial. **Do not** bump or touch the plunger. Doing so could cause the liquid to leak out. Insert the vial adaptor into the gray stopper on the Enbrel vial. The plastic spike inside the vial adaptor should puncture the gray stopper. The vial adaptor should fit snugly.

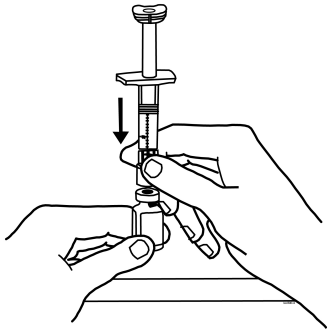

10. Hold the Enbrel vial upright on your flat work surface and push the plunger down until all the liquid from the syringe is in the Enbrel vial. You may see foaming (bubbles) in the vial. This is normal.

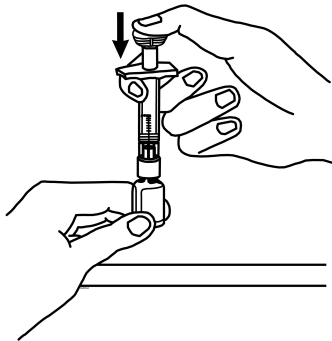

11. Gently swirl the Enbrel vial in a circular motion to dissolve the powder. If you used the dose tray to hold your Enbrel vial, take the vial (with the vial adaptor and syringe still attached) out of the dose tray, and gently swirl the vial in a circular motion to dissolve the powder.

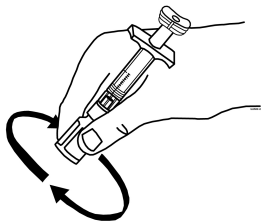

Do not shake. Wait until all the powder dissolves (usually less than 10 minutes). The solution should be clear and colorless. After the powder has completely dissolved, foam (bubbles) may still be present. This is normal. **Do not inject the solution if it is discolored, contains lumps, flakes, or particles.** If all the powder in the Enbrel vial is not dissolved or there are particles present after 10 minutes, call 1-888-4ENBREL (1-888-436-2735).

12. Turn the Enbrel vial upside down. Hold the syringe at eye level and slowly pull the plunger down to the unit markings on the side of the syringe that correspond with your/your child's dose. For adult patients, remove the entire volume (1 mL), unless otherwise instructed by your healthcare provider. Be careful not to pull the plunger completely out of the syringe. Some white foam may remain in the Enbrel vial. This is normal.

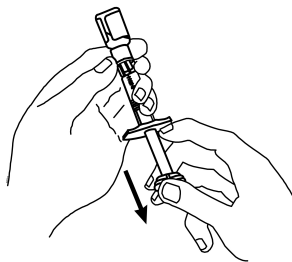

13. Check for air bubbles in the syringe. Gently tap the syringe to make any air bubbles rise to the top of the syringe. Slowly push the plunger up to remove the air bubbles. If you push solution back into the vial, slowly pull back on the plunger to again draw the correct amount of solution back into the syringe.

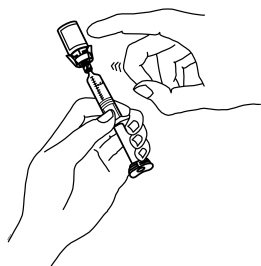

14. Remove the syringe from the vial adapter, by holding the vial adapter with one hand and turning the syringe counter-clockwise with your other hand. **Do not** touch or bump the plunger. Place the Enbrel vial with the vial adapter on your flat work surface.

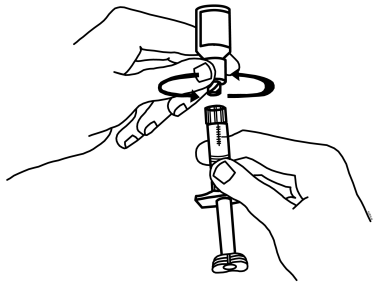

15. Continue to hold the barrel of the syringe. With your free-hand, twist the 27-gauge needle onto the tip of the syringe until it fits snugly. **Do not** remove the needle cover from the syringe. Place the syringe on your flat work surface until you are ready to inject Enbrel.

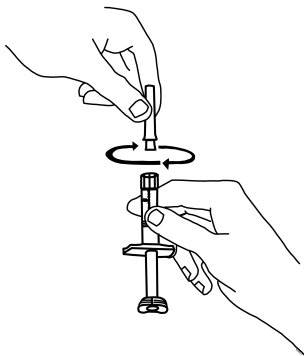

Go to Step 4: Choosing and Preparing an Injection Site.

Step 2B: Free-Hand Method

If you are preparing a dose from an Enbrel vial that was previously used, go to Step 3: Preparing Additional Doses from a Single Enbrel Vial.

1. Remove the pink plastic cap from the Enbrel vial. **Do not** remove the gray stopper or silver metal ring around the top of the Enbrel vial. Write the date you mix the powder and solution on the supplied "Mixing Date:" sticker and attach it to the Enbrel vial.

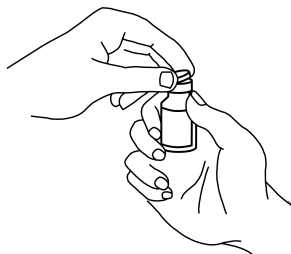
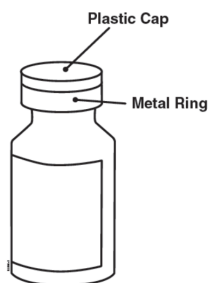

2. Place the Enbrel vial on your flat work surface. Use one alcohol swab to clean the gray stopper on the Enbrel vial. **Do not** touch the gray stopper with your hands.
3. Open the wrapper that contains the 25-gauge needle by peeling apart the tabs and set the needle aside for later use. The 25-gauge needle will be used to mix the liquid with the powder and for withdrawing Enbrel from the vial.

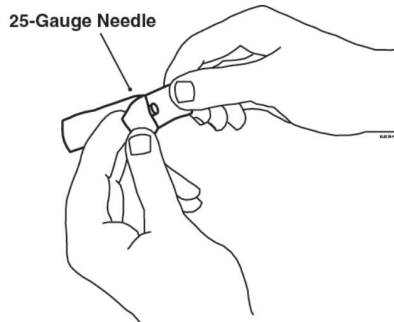

4. Slide the plunger into the flange end of the syringe.

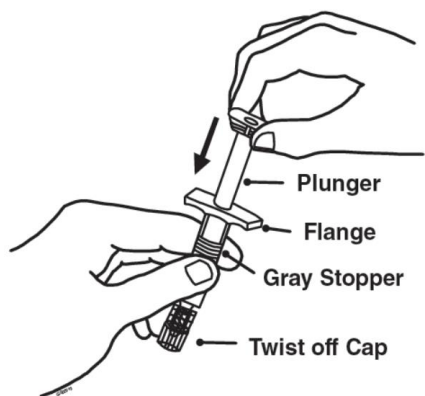

5. Attach the plunger to the gray rubber stopper in the syringe by turning the plunger clockwise until you feel a slight resistance.

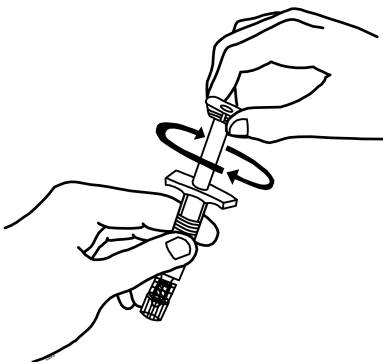

6. Remove the twist-off cap from the prefilled diluent syringe by turning counter-clockwise. **Do not** touch or bump the plunger. Doing so could cause the liquid to leak out. You may see a drop of liquid when removing the cap. This is normal. Place the cap on your flat work surface. **Do not** touch the syringe tip.



7. Continue to hold the barrel of the syringe. With your free-hand, twist the 25-gauge needle onto the tip of the syringe until it fits snugly. Place the syringe on your flat work surface.

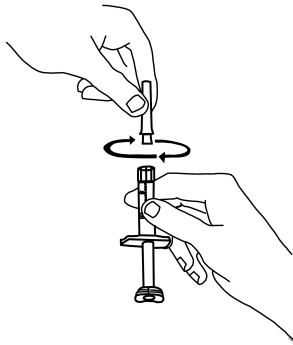

8. Open the wrapper that contains the 27-gauge needle by peeling apart the tabs and set the needle aside for later use. The 27-gauge needle will be used to inject the dose.

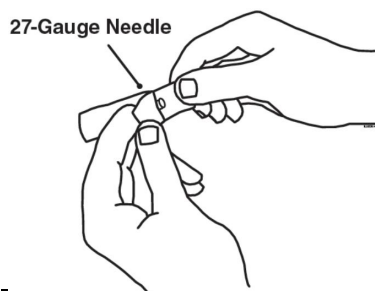

9. Pick up the syringe from your flat work surface. Hold the barrel of the syringe with one hand, and pull the needle cover straight off. To avoid damaging the needle, **do not** twist or bend the needle cover while you are removing it. **Do not** touch the needle or allow it to touch any surface. **Do not** touch or bump the plunger. Doing so could cause the liquid to leak out.

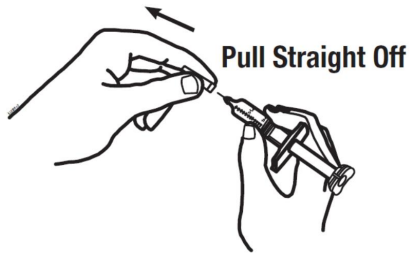

- Place the needle cover (open side up) in the round space marked “N” in the Enbrel dose tray.

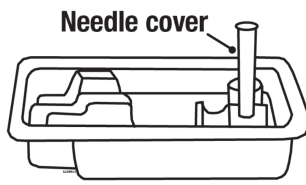

- Place the Enbrel vial on your flat work surface. Hold the syringe with the needle facing up, and gently pull back on the plunger to pull a small amount of air into the syringe. Then, insert the needle straight down through the center ring of the gray stopper (see illustrations). You should feel a slight resistance and then a “pop” as the needle goes through the center of the stopper. Look for the needle tip inside the open stopper window. If the needle is not correctly lined up with the center of the stopper, you will feel constant resistance as it goes through the stopper and no “pop”. The needle may enter at an angle and bend, break or prevent you from adding diluent into the Enbrel vial.

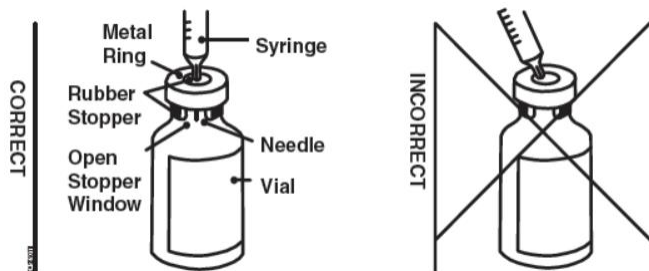

- Push the plunger down very slowly until all liquid from the syringe is in the Enbrel vial. Adding the liquid too fast will cause foaming (bubbles).

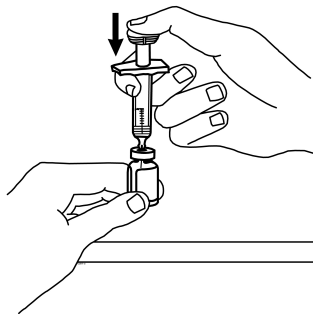

13. Leave the syringe in place. Gently swirl the Enbrel vial in a circular motion to dissolve the powder.

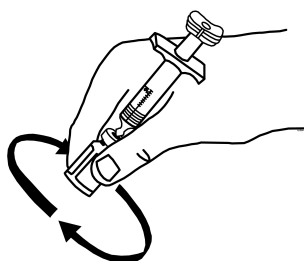

Do not shake. Wait until all the powder dissolves (usually less than 10 minutes). The solution should be clear and colorless. After the powder has completely dissolved, foam (bubbles) may still be present. This is normal. **Do not inject the solution if it is discolored, contains lumps, flakes, or particles.** If all the powder in the Enbrel vial is not dissolved or there are particles present after 10 minutes, call 1-888-4ENBREL (1-888-436-2735).

14. With the needle in the Enbrel vial, turn the vial upside down. Hold the syringe at eye level and slowly pull the plunger down to the unit markings on the side of the syringe that correspond with the correct dose. Make sure to keep the tip of the needle in the solution. Some white foam may remain in the Enbrel vial. This is normal.

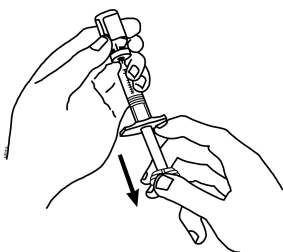

15. With the needle still inserted in the Enbrel vial, check for air bubbles in the syringe. Gently tap the syringe to make any air bubbles rise to the top of the syringe. Slowly push the plunger up to remove the air bubbles. If you push solution back into the vial, slowly pull back on the plunger to draw the correct amount of solution back into the syringe.

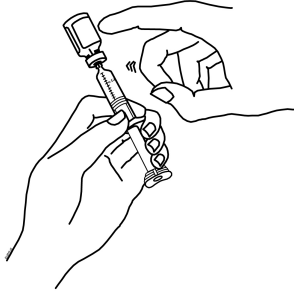

16. Remove the syringe and needle from the Enbrel vial. Keep the needle attached to the syringe and insert the 25-gauge needle straight down into the needle cover in the Enbrel dose tray.

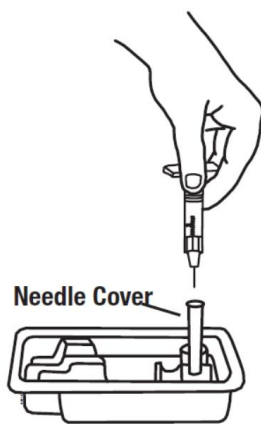

You should hear a “snap” when the needle is secure in the needle cover. Once the needle is secure in the needle cover, untwist the 25-gauge needle from the syringe and dispose of the needle in your sharps disposal container (see “**Step 6: Disposing of Supplies**”).

17. Twist the 27-gauge needle onto the syringe until it fits snugly. **Do not** remove the needle cover from the syringe. Place the syringe on your flat work surface until you are ready to inject Enbrel.

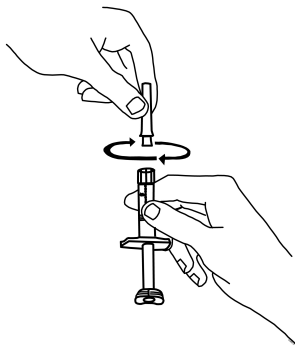

18. If there is enough solution left in the Enbrel vial for another dose, write the date you mixed the powder and liquid in the area marked "Mixing Date:" on the sticker supplied with these instructions, and attach the sticker to the Enbrel vial. Refrigerate the reconstituted (mixed) Enbrel vial (in the dose tray) after mixing. Prepare additional doses from the Enbrel vial as described in Step 3. Otherwise, throw away (discard) the Enbrel vial and any remaining solution.

Go to Step 4: Choosing and Preparing an Injection Site.

Step 3: Preparing Additional Doses from a Single Enbrel Vial

1. Select a clean, well-lit, flat work surface, such as a table.
2. **Do not** reuse the needles and syringes supplied with Enbrel dose tray. You will need new needles and syringes for each additional dose. Your healthcare provider will tell you what type of syringes (1 mL) and needles (25-gauge and 27-gauge) to use. Place the sterile syringe with a 25-gauge needle (for withdrawing Enbrel), a 27-gauge needle (for injecting Enbrel) and two alcohol swabs on your flat work surface.
3. Take the vial of Enbrel solution that is stored in the dose tray out of the refrigerator and place it on your flat work surface.
4. Check the mixing date you wrote on the sticker on the Enbrel vial. **Discard the Enbrel vial if more than 14 days have passed since the Enbrel solution was mixed.**
5. Wash your hands with soap and warm water.
6. Use one alcohol swab to clean the gray stopper on the Enbrel vial. **Do not** touch the stopper with your hands.
7. If the syringe and the 25-gauge needle are not pre-assembled, assemble them as instructed by your healthcare provider.
8. Open the wrapper that contains the 27-gauge needle by peeling apart the tabs and set the needle aside for later use. The 27-gauge needle will be used to inject the dose of Enbrel.
9. Hold the syringe and pull the needle cover straight off. To avoid damaging the needle, **do not** twist or bend the needle cover while you are removing it. **Do not** touch the needle or allow it to touch any surface. Place the needle cover (open side up) in the round space marked "N" in the Enbrel dose tray.
10. Place the Enbrel vial on your flat work surface. Hold the syringe with the needle facing up, and gently pull back the plunger to pull a small amount of air into the syringe. Then, insert the 25-gauge needle straight down through the center ring of the gray stopper. You should feel a slight resistance and then a "pop" as the needle goes through the center of the stopper. Look for the needle tip inside the open stopper window. If the needle is not

correctly lined up with the center of the stopper, you will feel constant resistance as it goes through the stopper and no “pop”. The needle may enter at an angle and bend, break, or prevent proper withdrawal of Enbrel solution from the vial.

11. Keep the needle in the Enbrel vial and turn the vial upside down. Hold the syringe at eye level, and slowly pull the plunger down to the unit markings on the syringe that correspond to your child’s dose. As the amount of solution in the Enbrel vial drops, you may need to pull the needle back just enough to keep the tip of the needle in the solution.
12. With the needle still inserted in the Enbrel vial, check for air bubbles in the syringe. Gently tap the syringe to make any air bubbles rise to the top of the syringe. Slowly push the plunger up to remove the air bubbles. If you push solution back into the Enbrel vial, slowly pull back on the plunger to again draw the correct amount of solution back into the syringe.
13. Remove the syringe and needle from the Enbrel vial. Keep the needle attached to the syringe and insert the 25-gauge needle straight down into the needle cover in the Enbrel dose tray. You should hear a “snap” when the needle is secure in the needle cover. Once the needle is secure in the needle cover, remove the 25-gauge needle from the syringe and dispose of the needle in a sharps disposal container (see “**Step 6: Disposing of Supplies**”).
14. Attach the 27-gauge needle onto the tip of the syringe until it fits snugly. **Do not** remove the needle cover from the syringe. Place the syringe on your flat work surface until you are ready to inject Enbrel.

Step 4: Choosing and Preparing an Injection Site

1. The 3 recommended injection sites for Enbrel include:
 - the front of the middle thighs
 - the stomach area (abdomen), except for the **2**-inch area right around the navel (belly button)

- the outer area of the upper arms (only if someone else is giving you the injection)

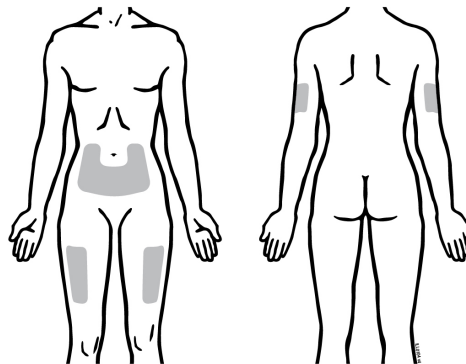

Front

Back

2. Rotate the site for each injection. **Do not** inject into areas where the skin is tender, bruised, red, or hard. Avoid areas with scars or stretch marks.
3. If you have psoriasis, you should not inject directly into any raised, thick, red, or scaly skin patches or lesions.
4. To prepare the area of skin where Enbrel is to be injected, wipe the injection site with a new alcohol swab. **Do not touch this area again before giving the injection.**

Step 5: Injecting the Enbrel Solution

Do not remove the needle cover from the syringe until you are ready to inject.

1. Pick up the syringe from your flat work surface. Hold the barrel of the syringe with one hand and pull the needle cover straight off. To avoid damaging the needle, **do not** twist or bend the needle cover while you are removing it, and **do not** try to put the needle cover back onto the syringe. When you remove the needle cover, there may be a drop of liquid at the end of the needle. This is normal. **Do not** touch the needle or allow it to touch any surface. **Do not** touch or bump the plunger. Doing so could cause the liquid to leak out.

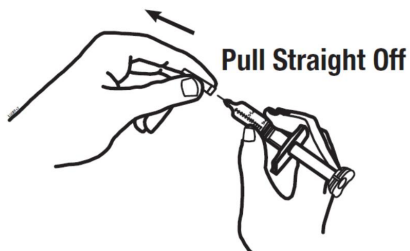

2. With one hand, gently pinch the cleaned area of skin and hold it firmly. With the other hand, hold the syringe (like a pencil) at a 45-degree angle to the skin.

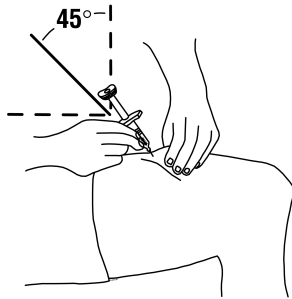

3. With a quick and "dart-like" motion, insert the needle at a 45-degree angle into the skin.
4. When the needle is completely inserted into the skin, let go of the skin that you are holding. With your free-hand, hold the syringe near its base to stabilize it. Then push the plunger to inject all of the Enbrel solution at a slow, steady rate.

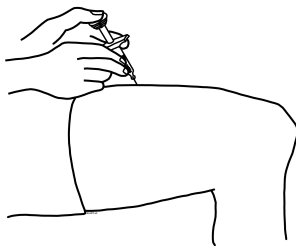

5. When the syringe is empty, pull the needle out of the skin, being careful to keep it at the same angle as inserted.
6. There may be a little bleeding at the injection site. You can press a cotton ball or gauze over the injection site for 10 seconds. **Do not** rub the injection site. If needed, you may cover the injection site with a bandage.
7. If your healthcare provider has instructed you to take two Enbrel injections on the same day, repeat the steps to prepare and give an injection of Enbrel. Choose and prepare a new injection site for the second injection.
8. **For the Free-Hand Method:** If there is enough solution left in the Enbrel vial for another dose, refrigerate the reconstituted (mixed) Enbrel vial (in the dose tray) after use. Otherwise, discard the Enbrel vial and any remaining solution.

Step 6: Disposing of Supplies

The syringe, needles, and vial adapter should **never** be reused. **Never** recap a needle.

- Put the used syringes, needles, and vials in a FDA-cleared sharps disposal container right away after use. **Do not** throw away (dispose of) the needles, syringes, and vials in your household trash.
- If you do not have a FDA-cleared sharps disposal container, you may use a household container that is:
 - made of a heavy-duty plastic,
 - can be closed with a tight-fitting, puncture-resistant lid, without sharps being able to come out,
 - upright and stable during use,
 - leak-resistant, and
 - properly labeled to warn of hazardous waste inside the container.
- When your sharps disposal container is almost full, you will need to follow your community guidelines for the right way to dispose of your sharps disposal container. There may be state or local laws about how you should throw away used syringes and needles. For more information about safe sharps disposal, and for specific information about sharps disposal in the state that you live in, go to the FDA's website at: <http://www.fda.gov/safesharpsdisposal>
- **Do not** reuse the syringe or vial.
- **Do not** recycle the syringe, vial, or sharps disposal container or throw them into household trash.

Important: Always keep the sharps disposal container out of the reach of children.

A healthcare provider familiar with Enbrel should answer all questions. Call 1-888-4ENBREL (1-888-436-2735) or visit www.enbrel.com for more information about Enbrel.

This Instructions for Use have been approved by the U.S. Food and Drug Administration.

AMGEN[®]

Manufactured by:

Immunex Corporation

Thousand Oaks, CA 91320-1799

U.S. License Number 1132

© 1998 – 2016, 2019 Immunex Corporation. All rights reserved.

1XXXXXX – v9

Revised: 10/2019

 This printed material is recyclable.

Front Panel Text

Read these instructions before using an AutoTouch® reusable autoinjector for use with Enbrel Mini® (etanercept) single-dose prefilled cartridge.

Side 1 Text

Your healthcare provider has prescribed Enbrel® AutoTouch reusable autoinjector for your injections. If your healthcare provider decides that you or a caregiver may be able to give your injections of Enbrel at home, you should receive training on the right way to prepare and inject Enbrel. Do not try to inject yourself until you have been shown the right way to give the injections by your healthcare provider. Call your healthcare provider if you or your caregiver has any questions about the right way to inject Enbrel.

Read these instructions before using an AutoTouch reusable autoinjector for use with Enbrel Mini (etanercept) single-dose prefilled cartridge.

Speed switch

Changing injection speed

The AutoTouch reusable autoinjector allows you to choose the speed of your injection. You can try the three speeds to decide which speed is most comfortable for you.

- Three speed settings are available: Fast, Medium, and Slow.
- The factory setting is set to Medium, the black dot (•).

To change the injection speed:

- For a **faster** injection, move the speed switch **up to the plus sign (+)**.
- For a **slower** injection, move the speed switch **down to the minus sign (-)**.

NOTE: When you receive your AutoTouch reusable autoinjector, the speed will be set to Medium (•). Set the injection speed **before** you place the autoinjector on your skin and press the start button. The injection speed cannot be changed after you begin an injection.

Speed switch moves up or down to adjust speed

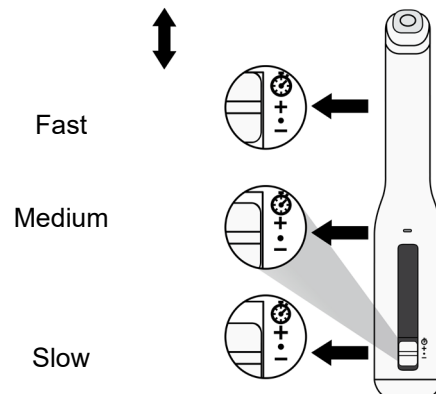

Sound switch

Turning sounds off

The AutoTouch autoinjector makes sounds (♪) to help guide your injection. When you receive a new autoinjector, it will be set with the sounds on (sound switch down).

- To turn off these sounds, slide the sound switch up (red bar is visible).
- Even when the sound is turned off, you will still hear the noise of the motor during the injection and will hear any error alerts to warn you there is a problem. See (Troubleshooting: Error symbols) below if you receive any error alerts.

Sound Switch

Sounds on

Slide switch down

Sounds off

Slide switch up (red bar is visible)

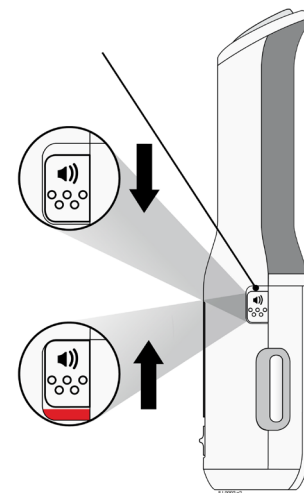

Turn over for step-by-step INSTRUCTIONS FOR USE and other information.

INSTRUCTIONS FOR USE
ENBREL® (en-brel)
(etanercept)
injection, for subcutaneous use
Enbrel Mini® Single-dose Prefilled Cartridge
for use with all AutoTouch® Reusable Autoinjectors

Guide to parts

AutoTouch reusable autoinjector

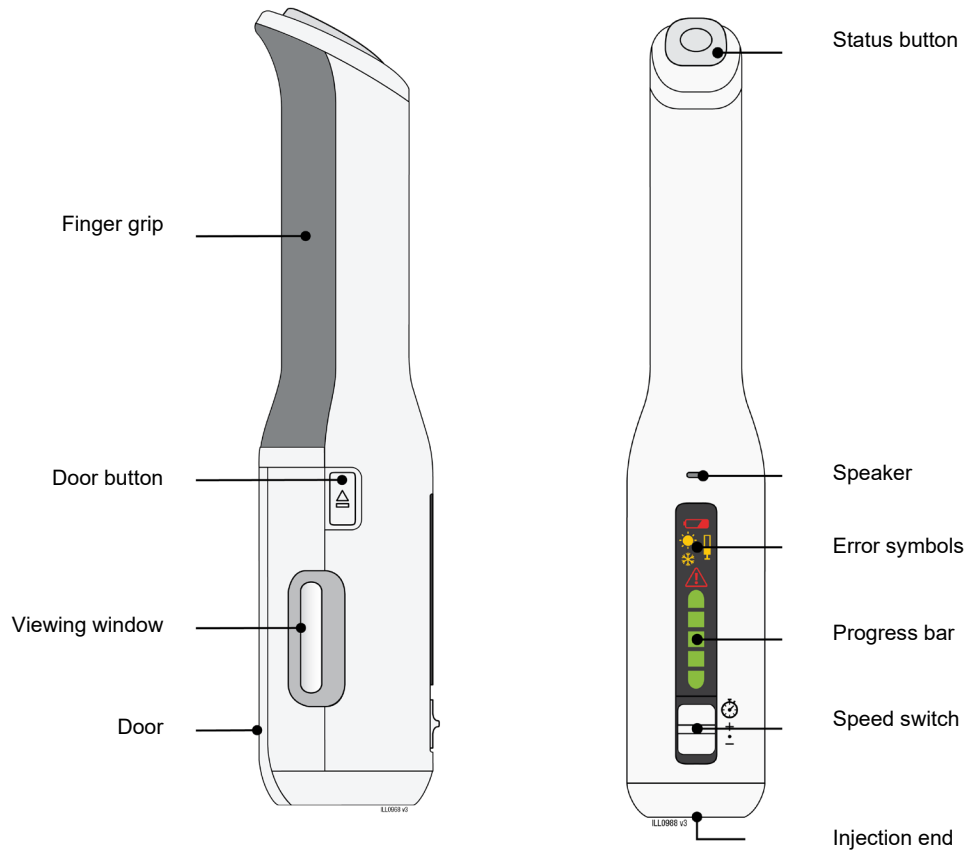

Enbrel Mini® single-dose cartridge

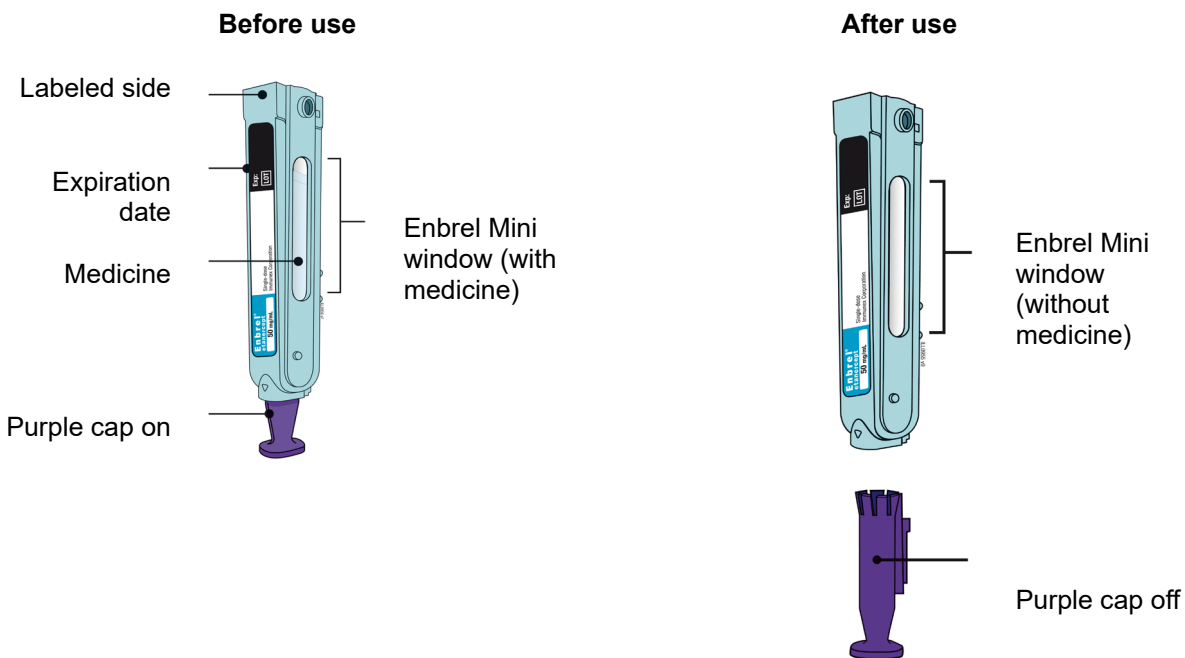

Important: The needle is inside Enbrel Mini.

Important

The AutoTouch® reusable autoinjector is used with the Enbrel Mini® single-dose prefilled cartridge to administer your dose of Enbrel®. The Enbrel Mini single-dose prefilled cartridge contains one 50 mg single-dose of Enbrel.

Before you use the AutoTouch reusable autoinjector with Enbrel Mini single-dose prefilled cartridge for use with Enbrel, read this important information:

Storing your Enbrel Mini single-dose cartridges:

- Store Enbrel Mini, which contains Enbrel, in the refrigerator between 36°F to 46°F (2°C to 8°C).
- If needed, you may store Enbrel Mini at room temperature between 68°F to 77°F (20°C to 25°C) for up to 30 days.
 - Once Enbrel has reached room temperature, do not put it back in the refrigerator.
- Throw away (dispose of) Enbrel Mini that has been stored at room temperature after 30 days.
- **Do not store Enbrel Mini in extreme heat or cold.** For example, avoid storing in your vehicle's glove box or trunk.
- **Do not freeze.**
- **Do not shake.**
- Store Enbrel Mini in the original carton to protect from light or damage.

Using your Enbrel Mini single-dose cartridges:

- It is important that you do not try to give the injection unless you or your caregiver has received training from your healthcare provider.
- **Do not** use Enbrel Mini after the expiration date printed on the label.
- **Do not** shake Enbrel Mini.
- **Do not** remove the purple cap from Enbrel Mini until it is inside the AutoTouch reusable autoinjector and you are ready to inject.
- **Do not** use Enbrel Mini if it has been dropped on a hard surface. Part of Enbrel Mini may be broken even if you cannot see the break. Use a new Enbrel Mini cartridge, and call 1-888-4Enbrel (1-888-436-2735).
- The needle cover inside the purple cap on the Enbrel Mini cartridge contains dry natural rubber, which is made from latex. Tell your healthcare provider if you are allergic to latex.
- Children must weigh at least 138 pounds to receive 50 mg Enbrel Mini. Children who weigh less than 138 pounds should receive a different form of Enbrel.

Storing your AutoTouch reusable autoinjector:

- Store AutoTouch at room temperature in a dry, safe place, such as a cabinet or drawer at 50°F to 104°F (10°C to 40°C).
- Use an alcohol wipe to clean the bottom (injection end) before and after each use.
- **Do not** store AutoTouch in the refrigerator with Enbrel Mini.

Keep Enbrel Mini and AutoTouch and all medicines out of the reach of children.

For more information or help, visit www.enbrel.com or call 1-888-4Enbrel (1-888-436-2735). Read your AutoTouch User Manual for additional care and storage information.

Step 1: Prepare

- A** Remove one Enbrel Mini® single-dose cartridge from the carton.
- Put the carton containing any unused Enbrel Mini back in the refrigerator.
 - Leave Enbrel Mini at room temperature for at least 30 minutes before injecting.
 - **Do not** put Enbrel Mini back in the refrigerator once it has reached room temperature.
 - **Do not** try to warm Enbrel Mini by using a heat source such as hot water or microwave.
 - **Do not shake** Enbrel Mini.
 - **Do not remove** the purple cap from Enbrel Mini yet.

B Inspect the Enbrel Mini single-dose prefilled cartridge.

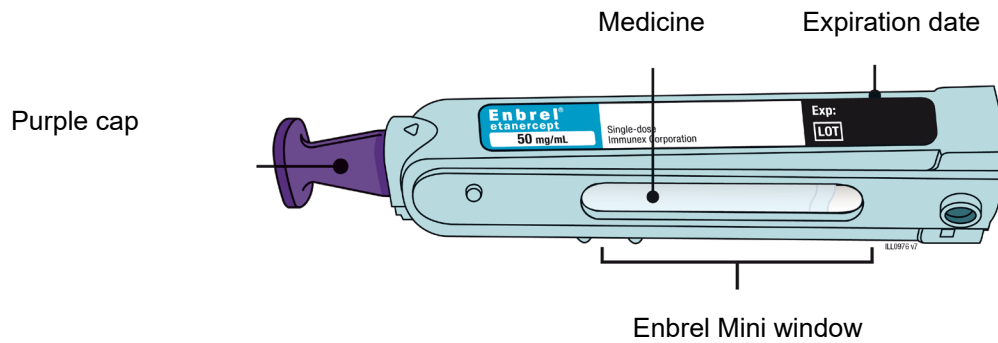

Make sure the medicine in the window is clear and colorless. It is okay if you see small white particles in the medicine window.

- **Do not** use Enbrel Mini if the medicine is cloudy, discolored, or contains large lumps, flakes, or colored particles.
- **Do not** use Enbrel Mini if any part appears cracked or broken.
- **Do not** use Enbrel Mini if the purple cap is missing or not securely attached.
- **Do not** use Enbrel Mini if the expiration date printed on the label has passed.

In all cases, use a new Enbrel Mini, and call 1-888-4Enbrel (1-888-436-2735).

C Gather all materials you need for your injection.

Wash your hands thoroughly with soap and water.

Place the following on a clean, well-lit, flat surface:

- AutoTouch®
- 1 Enbrel Mini®
- 3 alcohol wipes
- Cotton ball or gauze pad
- Adhesive bandage
- Sharps disposal container



AutoTouch



Enbrel Mini cartridge



3 Alcohol wipes



Cotton ball or gauze pad



Adhesive bandage



Sharps disposal container

D Prepare and clean your injection site.

Also clean the injection end of the AutoTouch® with a new alcohol wipe.

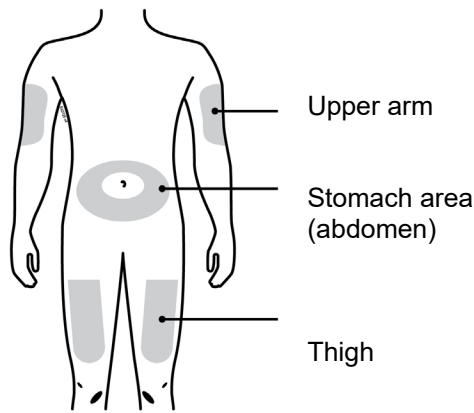

Injection end

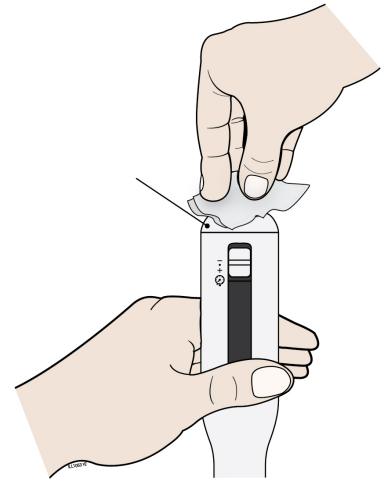

Clean your injection site with an alcohol wipe. Let your skin dry.

You can use:

- Your thigh
- Stomach area (abdomen), except for a 2-inch area right around your navel
- Outer area of upper arm (only if someone else is giving you the injection)

Important:

- **Do not** touch this area again before injecting.
- Choose a different site each time you give yourself an injection. If you want to use the same injection site, make sure it is not the same spot on the injection site you used for a previous injection.
- **Do not** inject into areas where the skin is tender, bruised, red, or hard. Avoid injecting into areas with scars or stretch marks.
- If you have psoriasis, you should avoid injecting directly into raised, thick, red, or scaly skin patches or lesions.

Step 2: Get ready

E Press the door button to open the door.

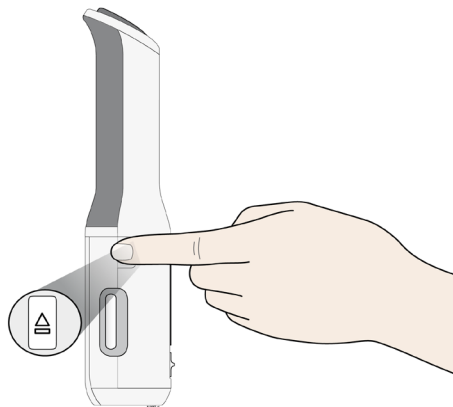

F Hold the Enbrel Mini® single-dose cartridge with the labeled side facing out and slide into door.

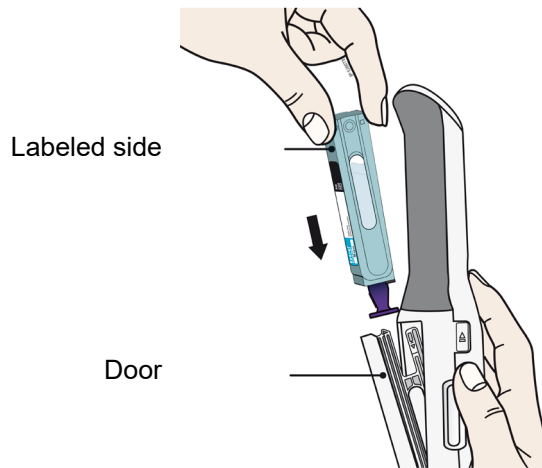

Hold with the labeled side facing out and the purple cap pointing down. Then slide Enbrel Mini into the door. It will slide all the way down into AutoTouch®.

- **Do not** force Enbrel Mini into AutoTouch if it does not slide in easily. Check that it is positioned correctly inside AutoTouch.

G Close the door.

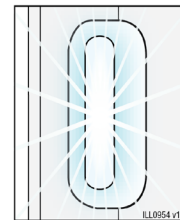
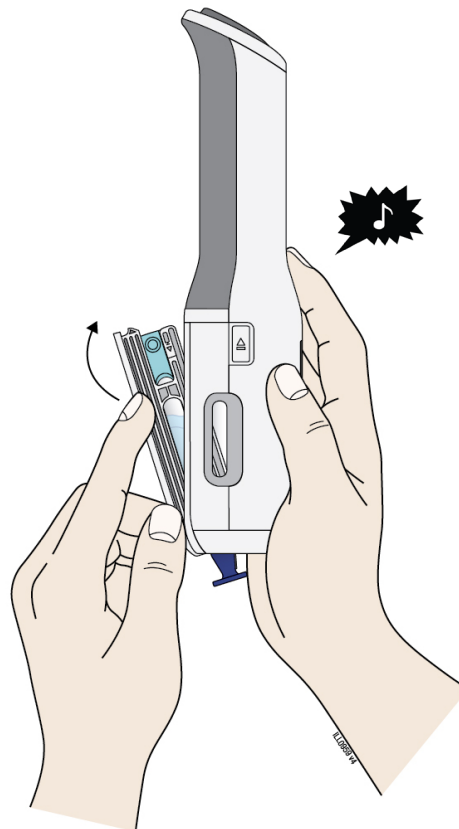

AutoTouch® is awake
when light is on in
viewing window

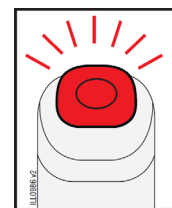

If you see a red
status button call
1-888-4Enbrel
(1-888-436-2735)

When you see the viewing window light up and hear a “chime”, this means that Enbrel Mini® has been loaded properly. AutoTouch is now in the awake mode.

Note: If the sound switch is set to the “sounds off” position, you will not hear this sound. To turn the “sounds on”, slide the sound switch down. The red bar will no longer be visible.

Sounds on

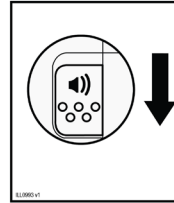

Slide switch down

Sounds off

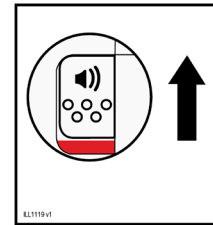

Slide switch up

Important: Do not remove the purple cap until you are ready to give your injection.

Step 3: Inject



Read the following information before proceeding with your injection.

You will now be performing the following tasks in order:

- Hold AutoTouch® correctly.
- Remove the purple cap.
- Confirm that AutoTouch is “awake”.
- Place and hold AutoTouch on the injection site.
- After the status button turns green, press the status button to start the injection.
- Wait for the injection to finish (ensure that AutoTouch maintains full contact with the skin).
- Confirm the injection is complete.

Do not give your injection until you have read these instructions and feel comfortable with how to use AutoTouch the right way.

H Hold the AutoTouch reusable autoinjector with fingers wrapped around the gray finger grip as shown.

- Before placing AutoTouch on your skin, make sure that AutoTouch is “awake”. Look to see that the viewing window light is on. If the viewing light is off this means it is in “sleep mode”, press the status button to “wake it up”.

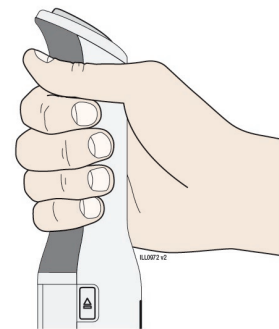

I When you are ready to inject, pull the purple cap straight down and off. **Do not** leave the purple cap off for more than 5 minutes. This can dry out the medicine.

Dispose of the purple cap in a sharps disposal container. Small parts such as the purple cap may cause a choking hazard for children and pets.

- The AutoTouch® site light will turn on to help you see the injection site.

It is normal to see a drop of liquid at the end of Enbrel Mini® needle or bottom of AutoTouch.

- **Do not** twist or bend the purple cap.
- **Do not** put the purple cap back onto AutoTouch.
- **Do not** remove the purple cap from AutoTouch until you are ready to inject.

If you are unable to inject, please contact your healthcare provider.

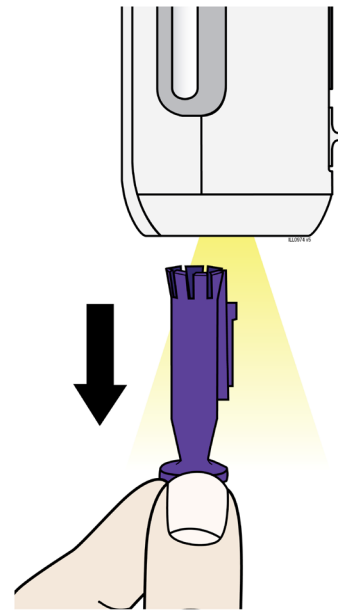

J Place and hold on the skin. Wait for the status button to turn green and a chime to sound.

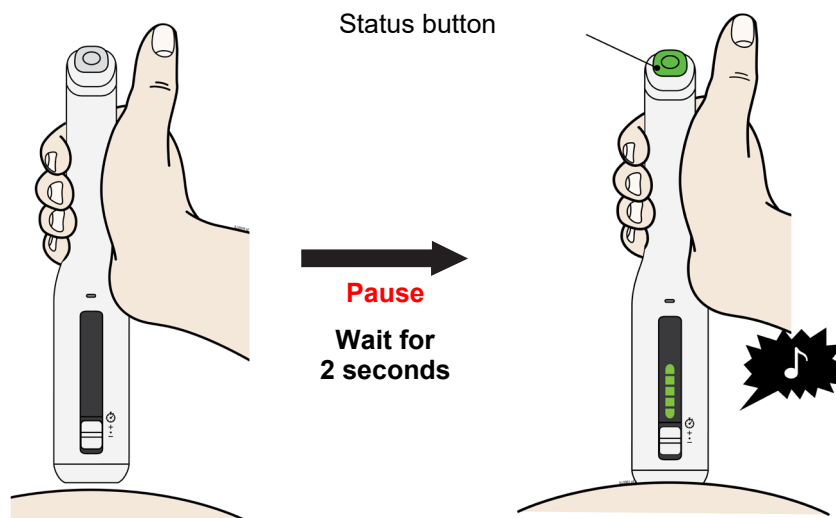

Gently place and hold the AutoTouch® reusable autoinjector on your skin and wait 2 seconds for the status button to turn green. You will hear a “chime” (unless the sound switch is set to the “sounds off” position).

- Keep your thumb off the status button during this step.
- **Do not** press the autoinjector hard on your skin. There is no need to stretch or pinch your skin.

- K** Press and release the status button. The status button will start to flash green. You will hear a click when the injection starts.

Press

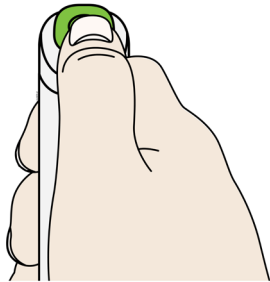

→
Status button
flashes green

Release

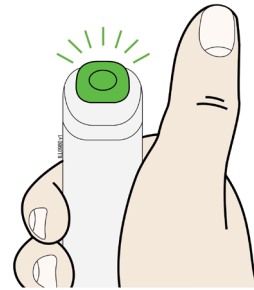

The green status button means your injection has started. You will hear a motor noise and the status button will flash green.

Important: Do not lift AutoTouch® off your skin while the injection is in progress. Continue to hold AutoTouch straight and steady.

- L** The injection is finished when the green light turns off and a “chime” sounds. Check to make sure you do not see a red status button.

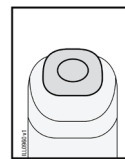
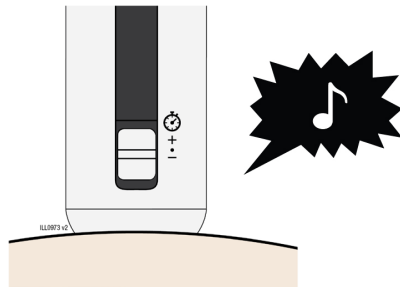

(light off)

Injection
finished

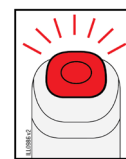

(red light on)

Injection error
Call 1-888-4Enbrel
(1-888-436-2735)

Lift AutoTouch® off your skin.

When your injection is finished, you will hear a motor noise for a few seconds. When finished, the door will automatically open. Do not block the door with your hand.

Door

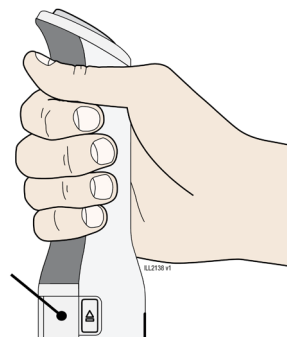

Important: When you remove AutoTouch, if the status button has turned red, call 1-888-4Enbrel (1-888-436-2735). If it looks like the medicine is still injecting or if you see medicine in the Enbrel Mini® window, this means you may not have received a full dose. Call your healthcare provider right away.

Step 4: Finish

M Remove and throw away (dispose of) the Enbrel Mini® single-dose prefilled cartridge.

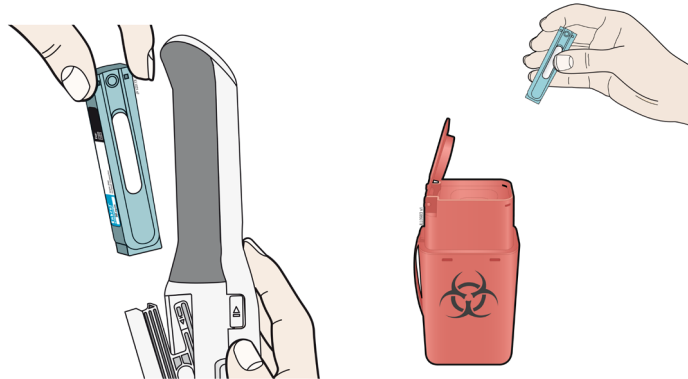

When the door opens, remove Enbrel Mini, close the door, then put it in an FDA-cleared sharps disposal container right away after use. Do not throw away (dispose of) Enbrel Mini in your household trash.

If you do not have an FDA-cleared sharps disposal container, you may use a household container that is:

- made of a heavy-duty plastic
- can be closed with a tight-fitting, puncture-resistant lid, without sharps being able to come out
- upright and stable during use
- leak-resistant, and properly labeled to warn of hazardous waste inside the container

When your sharps disposal container is almost full, you will need to follow your community guidelines for the right way to dispose of your sharps disposal container. There may be state or local laws about how you should throw away used needles and syringes. For more information about safe sharps disposal, and for specific information about sharps disposal in the state that you live in, go to the FDA's website at: <http://www.fda.gov/safesharpsdisposal>.

- **Do not** reuse Enbrel Mini.
- **Do not** recycle Enbrel Mini or the sharps disposal container or throw them into household trash.

Important: Always keep the sharps disposal container out of the reach of children.

N Examine the injection site.

If there is blood, press a cotton ball or gauze pad on your injection site. **Do not** rub the injection site. Apply an adhesive bandage, if needed.

O Clean and store the AutoTouch® reusable autoinjector.

Clean the injection end of the autoinjector with a new alcohol wipe and allow to dry.

Store AutoTouch at room temperature in a dry, safe place such as in a cabinet or drawer.

Important: **Do not** store AutoTouch in the refrigerator.

Troubleshooting: Error symbols

Why is the status button flashing red?



Low battery: The battery is very low. Only a few injections remain. Note: battery icon may be yellow on some devices. Call 1-888-4Enbrel (1-888-436-2735) for a replacement AutoTouch reusable autoinjector.



Battery dead: The battery is dead. Note: battery icon may be yellow on some devices. Call 1-888-4Enbrel (1-888-436-2735) for a replacement AutoTouch reusable autoinjector.



Too hot or too cold: AutoTouch reusable autoinjector is too hot, or too cold. Allow to naturally cool or warm to room temperature until symbols are gone.



Enbrel Mini® problem: There are several reasons you might get this error. See the User Manual for more information or call 1-888-4Enbrel (1-888-436-2735).



Needle exposure: The needle may be exposed and an incomplete dose may have been injected. Look for medicine in Enbrel Mini. Call your healthcare provider if you feel you have given yourself an incomplete injection. Take special care when removing and handling Enbrel Mini by disposing properly in the sharps container.



AutoTouch reusable autoinjector failure: Call 1-888-4Enbrel (1-888-436-2735) for reset instructions or a replacement AutoTouch reusable autoinjector.



This Instructions for Use has been approved by the U.S. Food and Drug Administration.

AMGEN®

Manufactured by:

Immunex Corporation

Thousand Oaks, CA 91320-1799

©1998 – 2018, 2021-2022 Immunex Corporation. All rights reserved.

[partnumber]

Revised: 06/2022 v6

U.S. License Number 1132



This printed material is recyclable.